

# SEMPLICE LED

ID CODE: 67

SEMPLICE is an **innovative lighting solution** suited to a wide range of interior applications including commercial, leisure and retail environments. Never before has a product been so versatile, with suspended or directly surface mounted versions available for wall and ceiling mounting. They can be individually installed, continuously mounted or even pattern formed using the tailored range of accessories. Unique in the fact that **light is emitted in all directions including the ends**, thanks to the integrated LED technology and translucent end caps. A broad collection matching products can be specified for free-standing and EUtrack mounting, giving the user continuity of product, but complete design freedom in a project.

See also:



**SEMPLICE wall/floor**

p. 374







**SEMPLICE LED HCL**

p. 485

## FEATURES

-  Direct/Indirect Emission
-  UGR <22
-  IP 40

## LED

-  3000K/4000K
-  >90 lm/W
-  CRI >90
-  Eye safety: RG0/RG1
-  Mac Adams 3
-  L80/B10 >50.000h

## CERTIFICATIONS

-  CE
-  A++
-  5 years warranty
- 

## ON REQUEST

-  DALI - RDD code (verify the version)
-  Emergency kit 1/3 hour EM/EM.3h code
-  2700K - 5000K



Design  
Quargnale // Ruatti studio Architetti

**Specifications** Built-in driver.

**Optic**

- PG for soft and homogenous emission without areas of shade
- EB for side emission

**Body**

Body - diffuser manufactured from shock-resistant, anti-static technopolymer, with an exclusive paint treatment to guarantee constant soft light homogeneity. End caps and joint accessories are produced in the same material to ensure seamless lines of light.

CONTINUOUS ROWS

SEMPLICE LED

CONTINUOUS ROWS

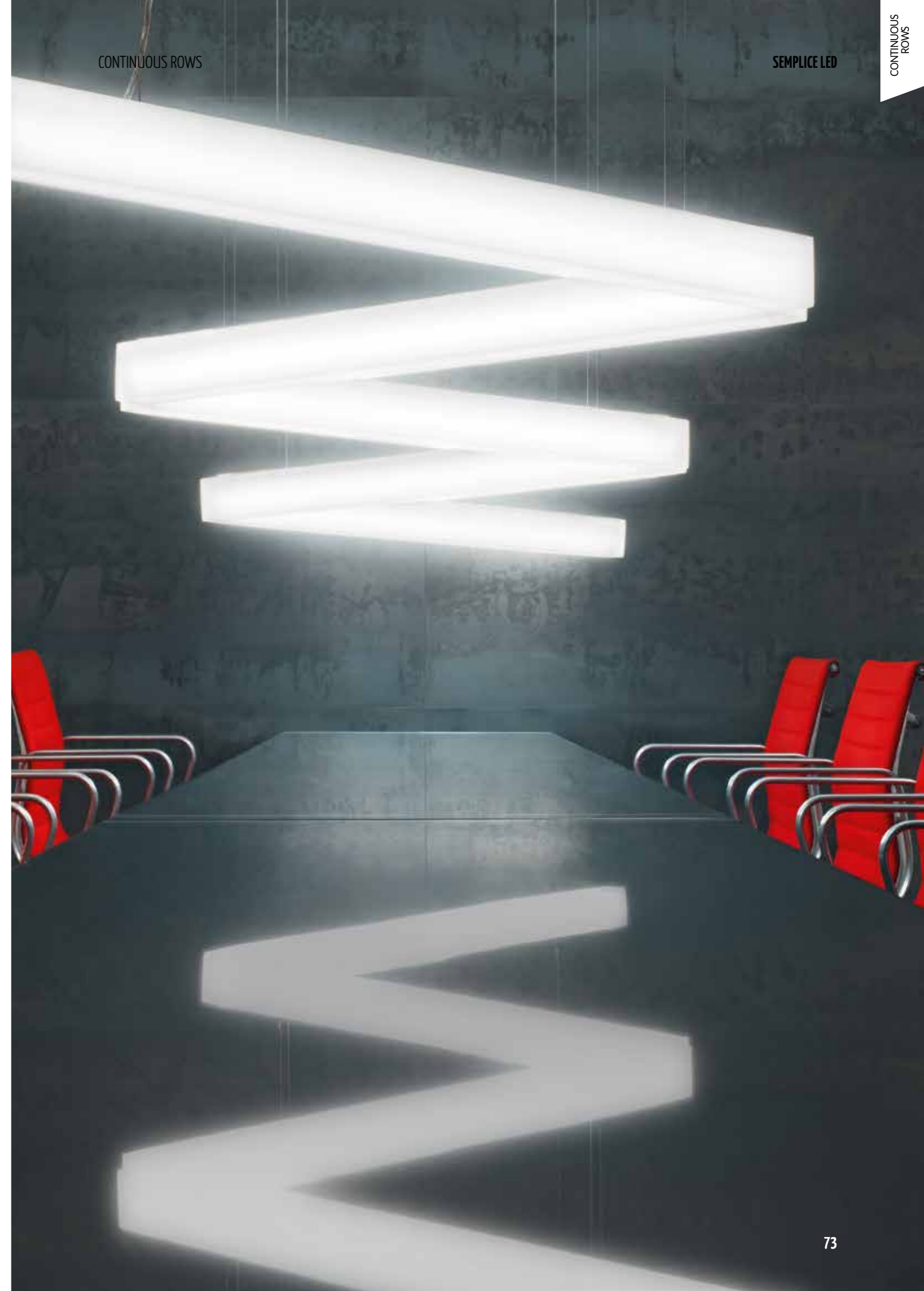

## SEMPLICE LED PG

### OPTIC

PMMA technopolymer (UGR<22) with surface treatment for completely uniform light distribution. Integrated LED technology.

See accessories on p. 77.

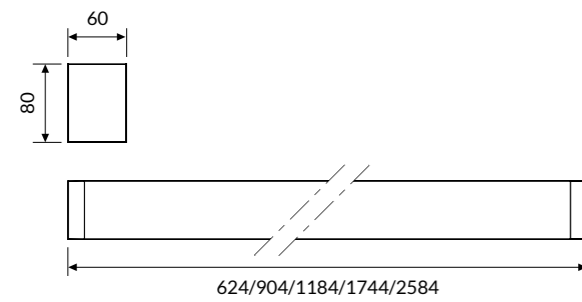

IP 40 A++

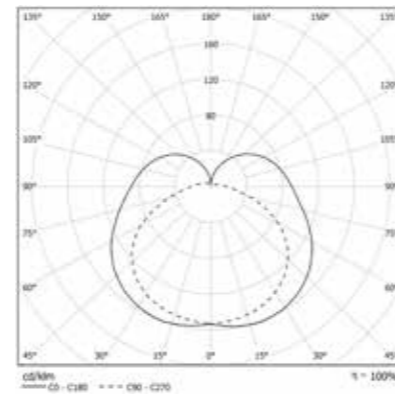

## SEMPLICE LED EB

### OPTIC

PMMA technopolymer (UGR<22) with surface treatment and super-pure aluminum reflector for bi-directional light distribution. Integrated LED technology.

See accessories on p. 77.

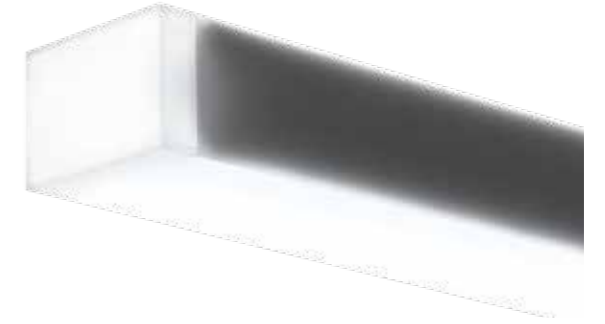

IP 40 A++

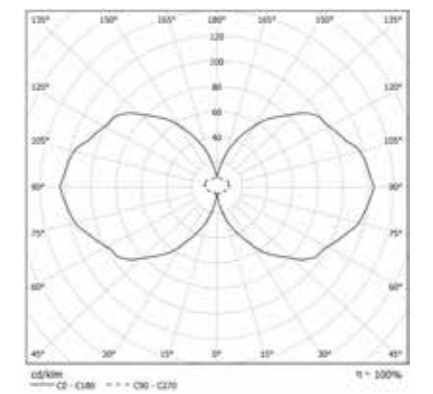
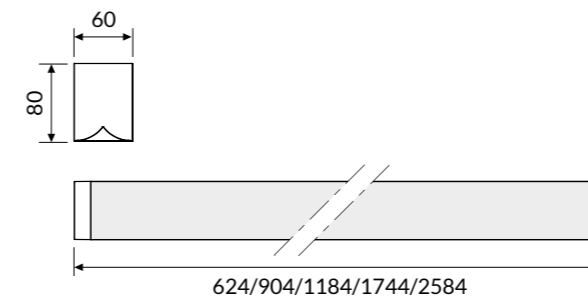

### COLOUR TEMPERATURE

4000K

3000K

COD	💡	lm	mm
67PG24L490HP	24W	2160	624
67PG36L490HP	36W	3240	904
67PG48L490HP	48W	4320	1184
67PG72L490HP	72W	6480	1744
67PG108L490HP	108W	9720	2584

COD	💡	lm	mm
67PG24L390HP	24W	2052	624
67PG36L390HP	36W	3078	904
67PG48L390HP	48W	4104	1184
67PG72L390HP	72W	6156	1744
67PG108L390HP	108W	9234	2584

### COLOUR TEMPERATURE

4000K

3000K

COD	💡	lm	mm
67EB24L490HP	24W	2064	624
67EB36L490HP	36W	3096	904
67EB48L490HP	48W	4128	1184
67EB72L490HP	72W	6192	1744
67EB108L490HP	108W	9288	2584

COD	💡	lm	mm
67EB24L390HP	24W	1961	624
67EB36L390HP	36W	2941	904
67EB48L390HP	48W	3922	1184
67EB72L390HP	72W	5882	1744
67EB108L390HP	108W	8824	2584

## SEMPlice LED EUTRACK

### OPTIC

PMMA technopolymer (UGR<22) with surface treatment for completely uniform light distribution. Integrated LED technology. Fitted with EUtrack connector.

See accessories on p. 77.

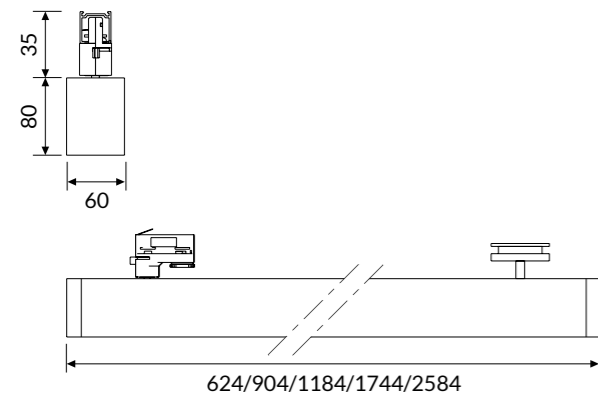

IP 40 A++

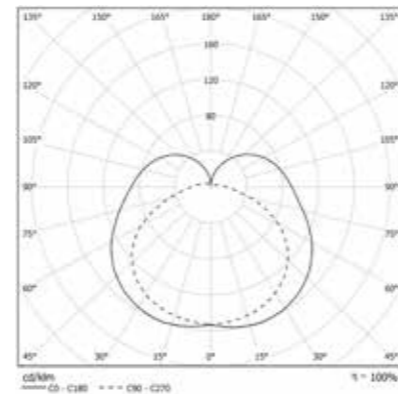

### COLOUR TEMPERATURE

4000K

COD	Light Bulb Icon	lm	mm
67PG24L490HPAB	24W	2160	624
67PG36L490HPAB	36W	3240	904
67PG48L490HPAB	48W	4320	1184
67PG72L490HPAB	72W	6480	1744
67PG108L490HPAB	108W	9720	2584

3000K

COD	Light Bulb Icon	lm	mm
67PG24L390HPAB	24W	2052	624
67PG36L390HPAB	36W	3078	904
67PG48L390HPAB	48W	4104	1184
67PG72L390HPAB	72W	6156	1744
67PG108L390HPAB	108W	9234	2584

## Accessories



**67AA13**  
Single wire 1500mm adjustable suspension kit.



**67AA1330**  
Single wire 3000mm adjustable suspension kit.



**67AA14**  
Spacers kit for wall/ceiling mounting.



**00AA16**  
3-poles powered supply box. Cable length 2000mm.



**00AA165P**  
5-poles powered supply box. Cable length 2000mm.



**67AA11LED**  
Electrified linear joint with total emission for continuous rows installation.



**67AA05**  
Internally electrified creative joint for horizontal change of direction.



**67AA05V**  
Internally electrified 90° joint for vertical change of direction.

## Technical Note

### FIXING DISTANCES FOR SUSPENSION

Light Bulb Icon	mm-min.	mm-max.
24W	300	450
36W	400	750
48W	600	1050
72W	800	1500
108W	1100	2240

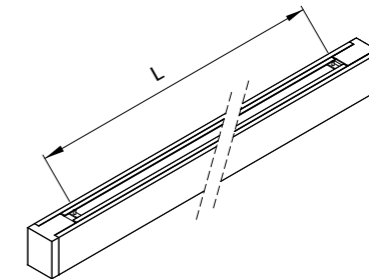

### MODULAR SYSTEM

The universal articulated joint is through-wired and facilitates the creation of unique shapes and pattern forms.

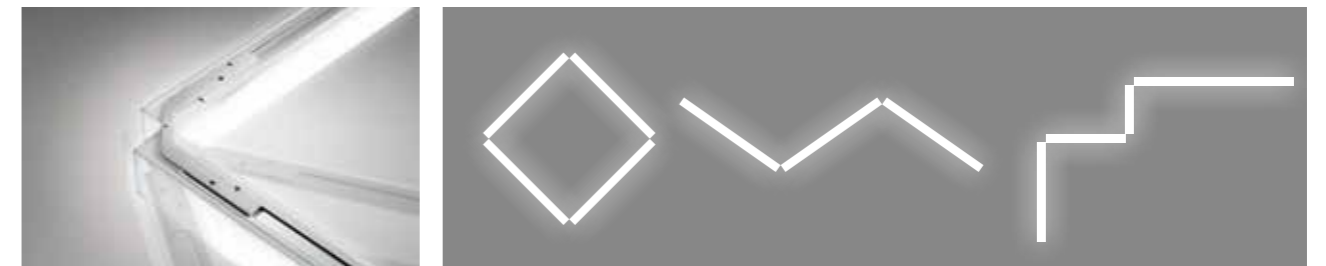

# SEMPLICE LED

ID CODE: 67

SEMPLICE is an innovative lighting solution suited to a wide range of interior applications including **commercial, leisure and retail environments**. Never before has a product been so versatile, with suspended or directly surface mounted versions available for wall and ceiling mounting. They can be individually installed, continuously mounted or even pattern formed using the tailored range of accessories. Unique in the fact that **light is emitted in all directions including the ends**, thanks to the integrated LED technology and translucent end caps. A broad collection matching products can be specified for free-standing and EUtrack mounting, giving the user continuity of product, but complete design freedom in a project.

See also:

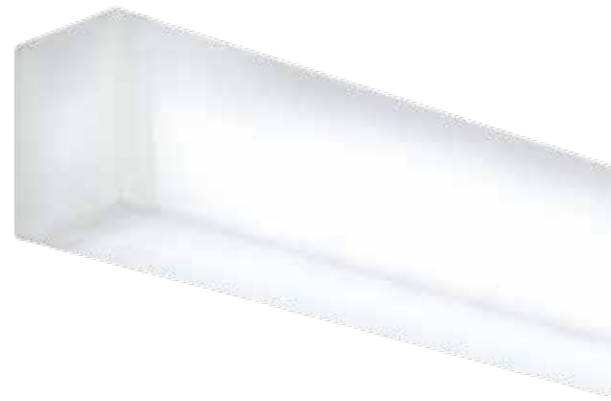

**SEMPLICE** p. 72

**SEMPLICE LED HCL** p. 485









Design  
Quargnale // Ruatti studio Architetti

## FEATURES

-  Direct/Indirect Emission
-  UGR <22
-  IP 40





## LED

-  3000K/4000K
-  >90 lm/W
-  CRI >90
-  Eye safety: RG0/RG1
-  Mac Adams 3
-  L80/B10 >50.000h

## CERTIFICATIONS

-  CE
-  A++
-  5 years warranty
- 

## ON REQUEST

-  DALI - RDD code (verify the version)
-  Bluetooth - BT code (verify the version)
-  Emergency kit 1/3 hour EM/EM 3h code
-  2700K - 5000K

**Specifications** Built-in driver.

**Optic**

- PG for soft and homogenous emission without areas of shade
- EB for side emission

**Body**

Body - diffuser manufactured from shock-resistant, anti-static technopolymer, with an exclusive paint treatment to guarantee constant soft light homogeneity. End caps and joint accessories are produced in the same material to ensure seamless lines of light.

WALL - FLOOR

SEMPLICE LED



WALL/FLOOR



## SEMPLICE LED PG

### OPTIC

PMMA technopolymer with surface treatment for completely uniform light distribution. Integrated LED technology.

Wall accessories not included.

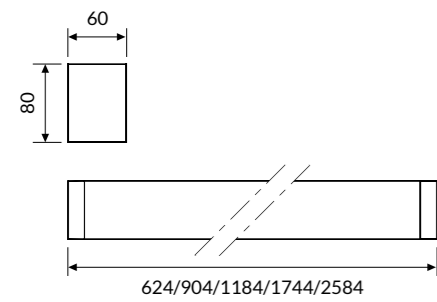

IP 40 A++

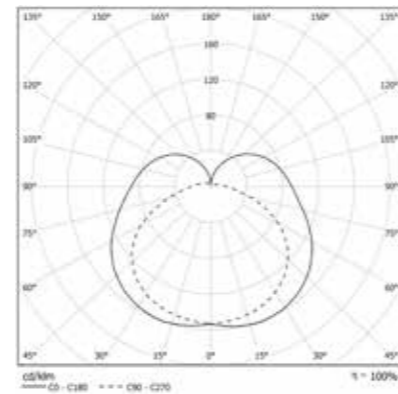

### COLOUR TEMPERATURE

4000K

3000K

COD	💡	lm	mm
67PG24L490HP	24W	2160	624
67PG36L490HP	36W	3240	904
67PG48L490HP	48W	4320	1184
67PG72L490HP	72W	6480	1744
67PG108L490HP	108W	9720	2584

COD	💡	lm	mm
67PG24L390HP	24W	2052	624
67PG36L390HP	36W	3078	904
67PG48L390HP	48W	4104	1184
67PG72L390HP	72W	6156	1744
67PG108L390HP	108W	9234	2584

## SEMPLICE LED EB

### OPTIC

PMMA technopolymer with surface treatment and super-pure aluminum reflector for bi-directional light distribution. Integrated LED technology.

Wall accessories not included.

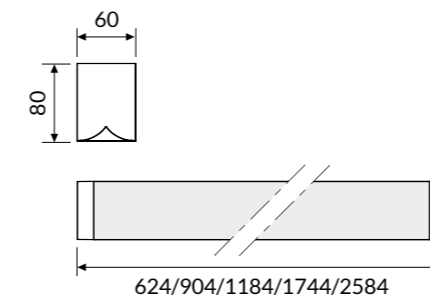
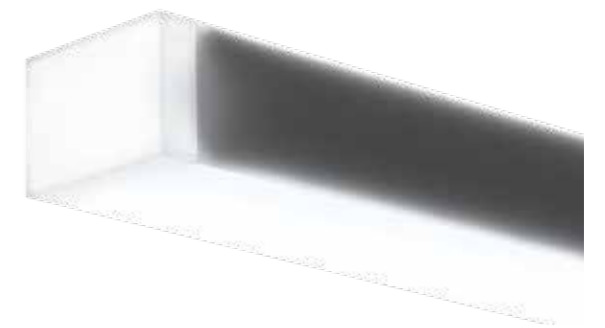

IP 40 A++

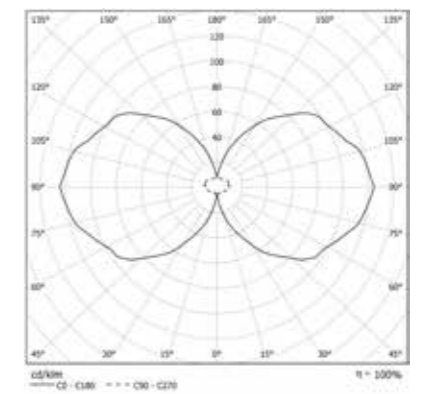

### COLOUR TEMPERATURE

4000K

3000K

COD	💡	lm	mm
67EB24L490HP	24W	2064	624
67EB36L490HP	36W	3096	904
67EB48L490HP	48W	4128	1184
67EB72L490HP	72W	6192	1744
67EB108L490HP	108W	9288	2584

COD	💡	lm	mm
67EB24L390HP	24W	1961	624
67EB36L390HP	36W	2941	904
67EB48L390HP	48W	3922	1184
67EB72L390HP	72W	5882	1744
67EB108L390HP	108W	8824	2584

## SEMPLICE LED FLOOR

### OPTIC

PMMA technopolymer with surface treatment for completely uniform light distribution. Supplied with a metal base with universal joint for head rotation.

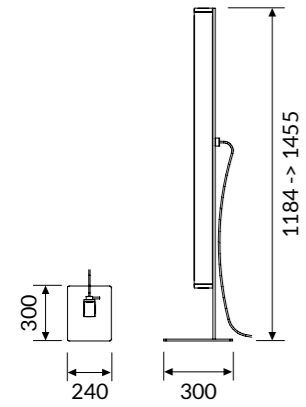

IP 40 A++

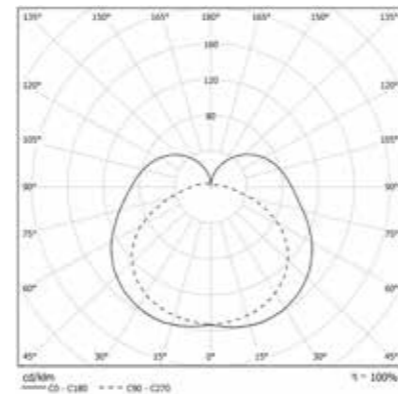

### COLOUR TEMPERATURE

4000K

COD	⚡	lm
67PG48L490HPT	48W	4320

3000K

COD	⚡	lm
67PG48L390HPT	48W	4104

## Accessories



**67AA14**  
Spacers kit for wall/ceiling mounting.



**67AA11LED**  
Electrified linear joint with total emission for continuous rows installation.

## Technical Note

### SEMPLICE FLOOR

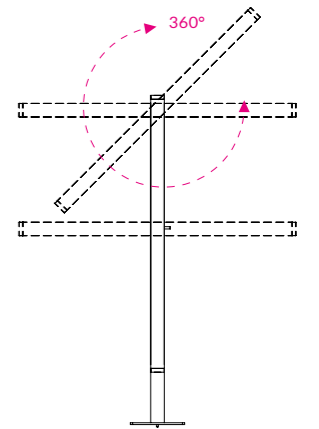
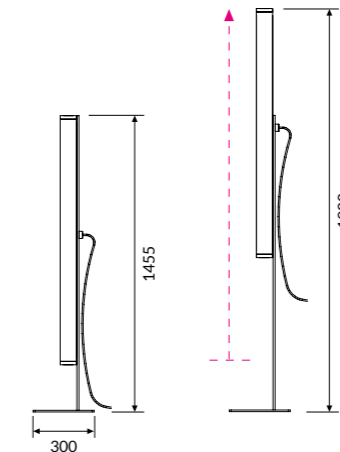
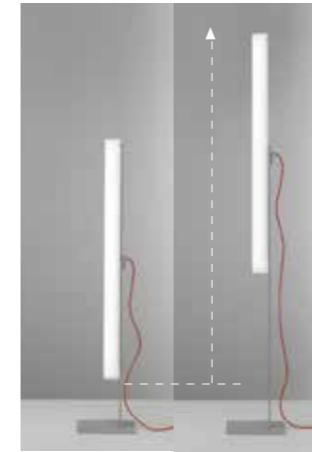

### FIXING DISTANCES FOR SUSPENSION

⚡	mm-min.	mm-max.
24W	300	450
36W	400	750
48W	600	1050
72W	800	1500
108W	1100	2240

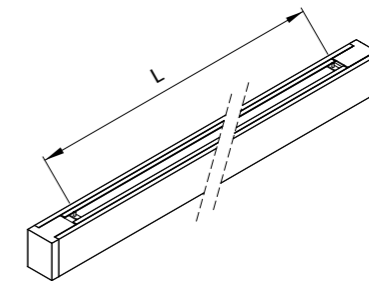

### MODULAR SYSTEM

The universal articulated joint is through-wired and facilitates the creation of unique shapes and pattern forms.

