

ONE RING





ID CODE: 17

ONE RING is a decorative yet highly technical fixture with minimalist design and multiple application possibilities. Available in a range of diameters, for direct ceiling mounting or for suspending, with direct or direct/indirect light emission and the possibility of adding adjustable spotlights for accent lighting. With the option of adding central acoustic with sound absorption panels, ONE RING is a truly unique lighting solution.









Design
esse-ci

FEATURES

-  Direct Emission
-  Direct/Indirect Emission
-  UGR <22; <19
-  IP 40



LED

-  3000K/4000K
-  >107 lm/W
-  CRI >90
-  Eye safety: RG0/RG1
-  Mac Adams 3
-  L80/B10 >50.000h

CERTIFICATIONS

-  CE
-  A+
-  5 years warranty

ON REQUEST

-  DALI - RDD code (verify the version)
-  Emergency kit 1/3 hour EM/EM.3h code
-  2700K

Optic

- PG diffuser for soft diffusion with UGR<22
- DPL impact resistant with homogeneous and controlled emission UGR<19

Body

Manufactured from extruded aluminum with epoxy powder coating.

Colour

- White RAL 9003 - Code: B
- Black RAL 9005 - Code: C8



ONE RING PG

OPTIC

Methacrylate satin diffuser for soft diffusion with UGR<22.

Complete with powered box.

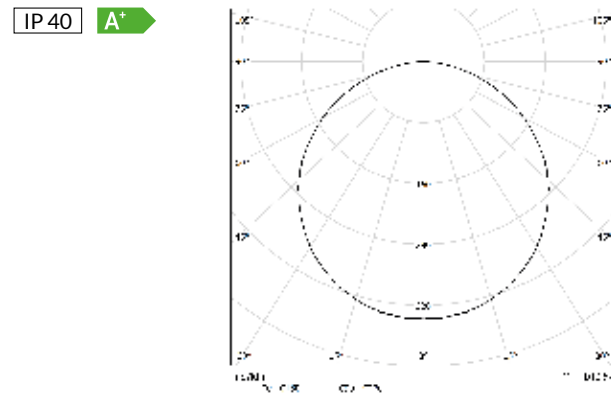
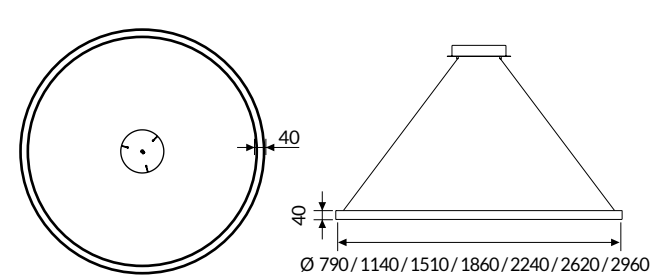

COLOUR TEMPERATURE

4000K

COD	💡	lm	Ø (mm)
17PG39L490	39W	4173	790
17PG58L490	58W	6216	1140
17PG77L490	77W	8288	1510
17PG96L490	96W	10360	1860
17PG115L490	115W	12432	2240
17PG134L490	134W	14504	2620
17PG154L490	154W	16576	2960

3000K

COD	💡	lm	Ø (mm)
17PG39L390	39W	3881	790
17PG58L390	58W	5780	1140
17PG77L390	77W	7708	1510
17PG96L390	96W	9635	1860
17PG115L390	115W	11562	2240
17PG134L390	134W	13489	2620
17PG154L390	154W	15416	2960

ONE RING PG DOUBLE EMISSION

OPTIC

Methacrylate satin diffuser for soft diffusion with UGR<22. Direct/Indirect emission.

Complete with powered box.

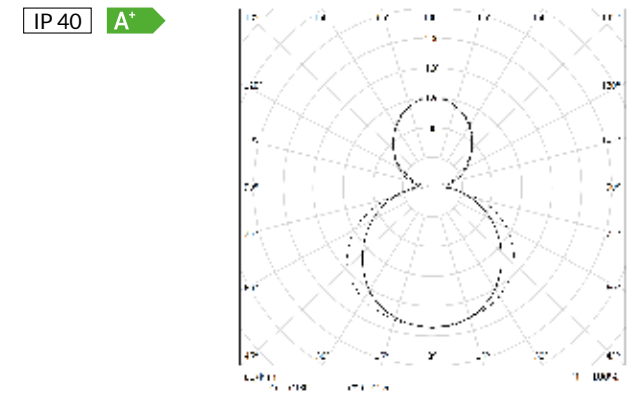
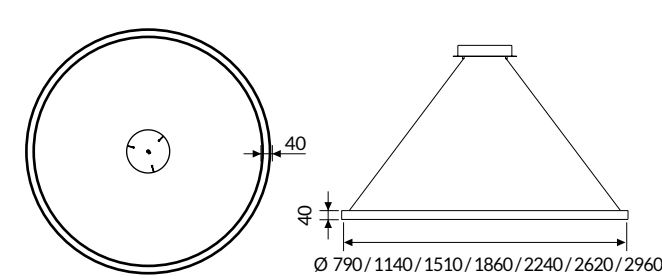

DIRECT // INDIRECT EMISSION

Ø (mm)	Power Direct Mod.	Power Indirect Mod.
790	39W	24W
1140	58W	35W
1510	77W	46W
1860	96W	57W
2240	115W	69W
2620	134W	81W
2960	154W	92W

COLOUR TEMPERATURE

4000K

COD	💡	lm	Ø (mm)
17DI63PGL490	63W	6057	790
17DI93PGL490	93W	8966	1140
17DI123PGL490	123W	11588	1510
17DI153PGL490	153W	14760	1860
17DI184PGL490	184W	17382	2240
17DI215PGL490	215W	20554	2620
17DI246PGL490	246W	23726	2960

3000K

COD	💡	lm	Ø (mm)
17DI63PGL390	63W	5578	790
17DI93PGL390	93W	8255	1140
17DI123PGL390	123W	10678	1510
17DI153PGL390	153W	13595	1860
17DI184PGL390	184W	16017	2240
17DI215PGL390	215W	18934	2620
17DI246PGL390	246W	21851	2960

ONE RING DPL

OPTIC

Diffuser in DPL (Diamond Prism LED) technology with UGR<19 for projects with display screen equipment.

Complete with powered box.

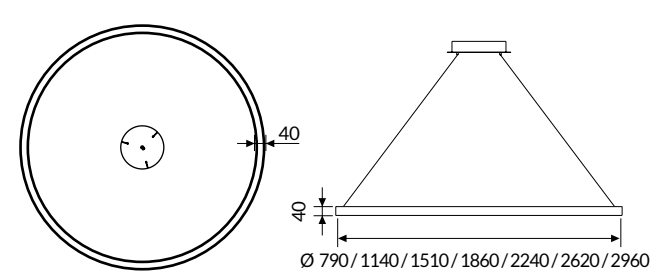

IP 40 A'

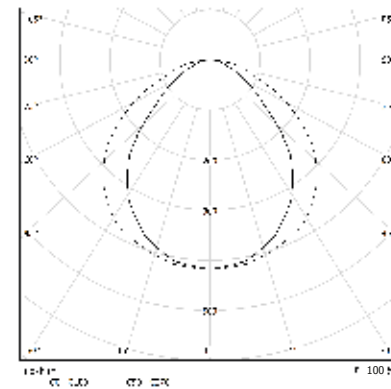

COLOUR TEMPERATURE

4000K

COD	Light Bulb Icon	lm	Ø (mm)
17DPL39L490	39W	3950	790
17DPL58L490	58W	5880	1140
17DPL77L490	77W	7840	1510
17DPL96L490	96W	9800	1860
17DPL115L490	115W	11760	2240
17DPL134L490	134W	13720	2620
17DPL154L490	154W	15680	2960

3000K

COD	Light Bulb Icon	lm	Ø (mm)
17DPL39L390	39W	3674	790
17DPL58L390	58W	5468	1140
17DPL77L390	77W	7291	1510
17DPL96L390	96W	9114	1860
17DPL115L390	115W	10937	2240
17DPL134L390	134W	12760	2620
17DPL154L390	154W	14582	2960

ONE RING DPL DOUBLE EMISSION

OPTIC

Diffuser in DPL (Diamond Prism LED) technology with UGR<19 for projects with display screen equipment.

Direct/Indirect emission.

Complete with powered box.

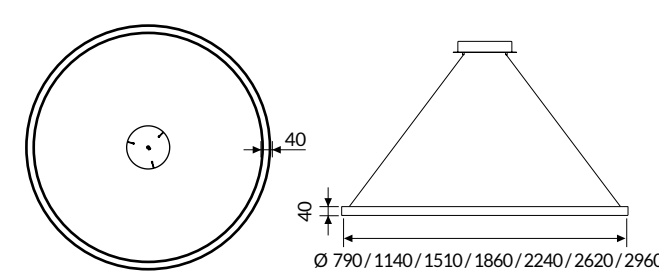

IP 40 A'

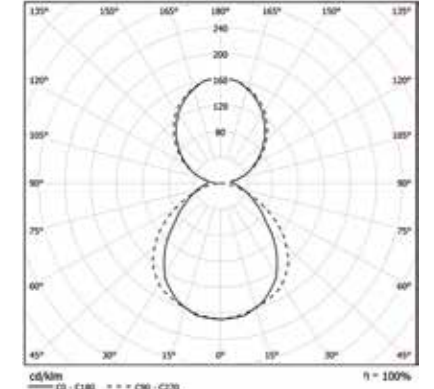

DIRECT // INDIRECT EMISSION

Ø (mm)	Power Direct Mod.	Power Indirect Mod.
790	39W	24W
1140	58W	35W
1510	77W	46W
1860	96W	57W
2240	115W	69W
2620	134W	81W
2960	154W	92W

COLOUR TEMPERATURE

4000K

COD	Light Bulb Icon	lm	Ø (mm)
17DI63DPLL490	63W	5834	790
17DI93DPLL490	93W	8630	1140
17DI123DPLL490	123W	11140	1510
17DI153DPLL490	153W	14200	1860
17DI184DPLL490	184W	16710	2240
17DI215DPLL490	215W	19770	2620
17DI246DPLL490	246W	22830	2960

3000K

COD	Light Bulb Icon	lm	Ø (mm)
17DI63DPLL390	63W	5371	790
17DI93DPLL390	93W	7943	1140
17DI123DPLL390	123W	10261	1510
17DI153DPLL390	153W	13074	1860
17DI184DPLL390	184W	15392	2240
17DI215DPLL390	215W	18205	2620
17DI246DPLL390	246W	21017	2960

ONE RING SPOT

OPTIC

Methacrylate satin diffuser for soft diffusion with UGR<22. Spot with internal aluminum reflector 36° beam angle.

Complete with powered box.

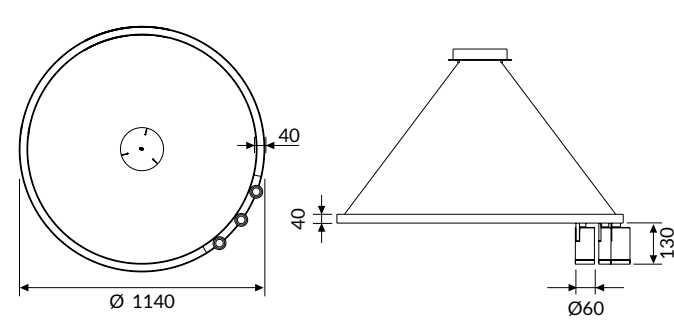

IP 40 A+
Spot:
IP 20 A

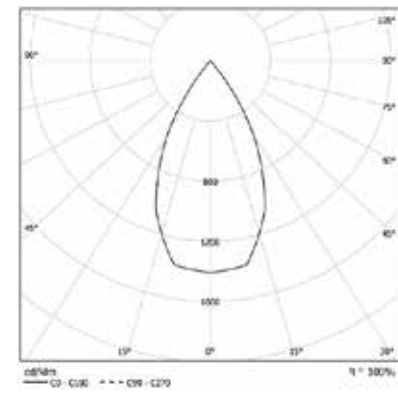
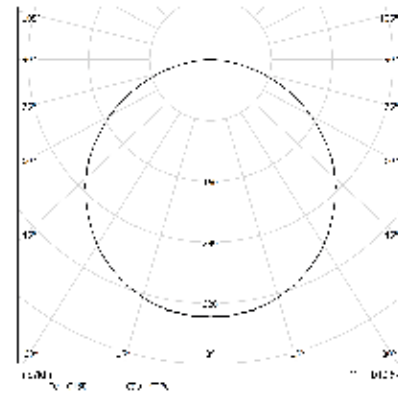

COLOUR TEMPERATURE 4000K 3000K

COD	Light Bulb Icon	lm	Ø (mm)
17PG43L4903x36	43W + 3x9W 36°	4601 + 3282	1140

COD	Light Bulb Icon	lm	Ø (mm)
17PG43L3903x36	43W + 3x9W 36°	4279 + 2769	1140

ONE RING ACOUSTIC DOUBLE EMISSION

OPTIC

Methacrylate satin diffuser for soft diffusion with UGR<22. Direct/Indirect emission.

Grey sound absorbing panel. Complete with powered box.

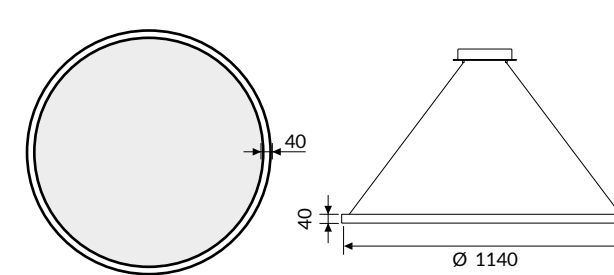

IP 40 A+

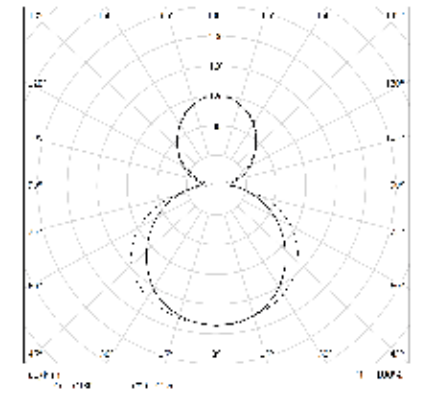

DIRECT // INDIRECT EMISSION

Ø (mm)	Power Direct Mod.	Power Indirect Mod.
1140	58W	35W

COLOUR TEMPERATURE 4000K 3000K

COD	Light Bulb Icon	lm	Ø (mm)
17DI93PGL490AC	93W	8966	1140

COD	Light Bulb Icon	lm	Ø (mm)
17DI93PGL390AC	93W	8255	1140

Accessories



17AA1330
Single wire 3000mm long adjustable suspension.



17AA14
Kit for ceiling mounting.