

Gli apparecchi non sono idonei ad essere coperti con materiale termoisolante

Luminaires not suitable for covering with thermally insulating material

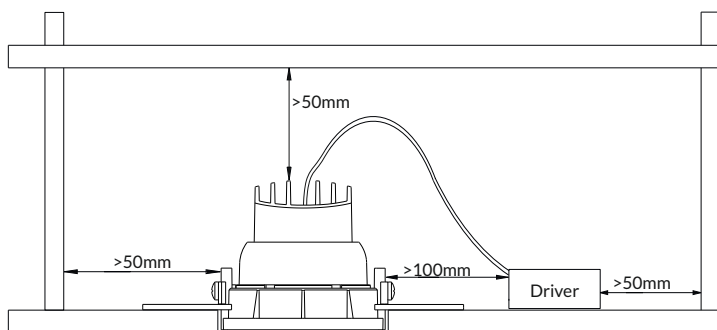

// **Avvertenze.** La sicurezza dell'apparecchio è garantita solamente con l'uso appropriato delle presenti istruzioni che devono essere lette e conservate. • Togliere tensione di rete prima della sostituzione delle lampade e comunque prima di ogni operazione di manutenzione. • Non coprire l'apparecchio con panni o con quant'altro possa causare un eccessivo surriscaldamento. • La nostra azienda declina ogni responsabilità per danni causati da uno scorretto utilizzo o dalla manomissione dell'apparecchio stesso. • Per la sostituzione di componenti usurati rivolgersi a personale qualificato. • L'apparecchio non deve essere smaltito come rifiuto urbano. Deve essere soggetto a raccolta separata per evitare danni all'ambiente nel rispetto della direttiva 2002/96 e delle leggi nazionali per lo smaltimento del prodotto a fine vita. Il mancato rispetto di quanto sopra è sanzionato dalla Legge. • Si prega di informarsi in merito al sistema locale di raccolta differenziata per i prodotti elettrici ed elettronici. Apparecchio per uso solo in ambienti interni. Qualora il cavo flessibile fosse danneggiato, dovrà essere sostituito esclusivamente dal produttore mediante un suo incaricato oppure da un tecnico qualificato.

// **Warning.** The safety of the fixture is guaranteed only under the correct use of the present instructions, which have to be read and kept. • Turn off the net voltage before the replacement of the lamp and however before any maintenance action. • Do not cover the fixture with clothes or something else which could cause an excessive overheating. • Our company declines all responsibility for damages caused by an incorrect use or by the tampering of fixture itself. • For replacement of worn out components please address to the skilled staff. • The fixture could not be disposed as urban waste. It must be subject to a separate waste collection to avoid environmental damage in compliance with directive 2002/96 and national laws for the disposal of product at the end of its working life. The non-compliance of the above mentioned directive will be sanctioned by Law. • We ask you to kindly get information about local separate waste collection system for electric and electronic products. For indoor use only. If the external flexible cable is damaged it shall be replaced exclusively by the manufacturer by his service agent or by a qualified technicians.









ISHLFL_Rev.02

HALL LED FL

// Istruzioni per il montaggio // Assembly instructions

CE

A+

-  5 years warranty
-  Direct Emission
-  UGR < 19
-  3000K/4000K
-  >99 lm/W
-  CRI >90
-  Eye safety: RG0/RG1
-  Mac Adams 3
-  L80/B10 >50.000h



Attenzione: prima di procedere con ciascuna delle seguenti operazioni, togliere la tensione di rete ed utilizzare i dispositivi di protezione individuale (guanti, occhiali, scarpe)

Attention: before proceeding with each of the following operations, switch off the power supply at the consumer unit. Use personal protective equipment.



Attenzione: NON ADATTO ALL'INSTALLAZIONE ALL'ESTERNO
Attention: NOT SUITABLE FOR OUTDOOR APPLICATION.

esse-ci
LIVING LIGHT

ESSE-CI s.r.l.
Viale del Lavoro 25, 35010 Vigonza (PD) Italy
T. +39 049 8959511 // info@esse-ci.it
esse-ci.it

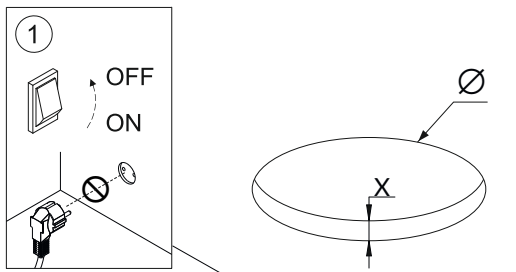

2

Size	Ø	X
Mini	75mm	5<X<15mm
Small	150mm	5<X<20mm

