

Luminaires not suitable for covering
with thermally insulating material
Gli apparecchi non sono idonei ad essere coperti
con materiale termoisolante

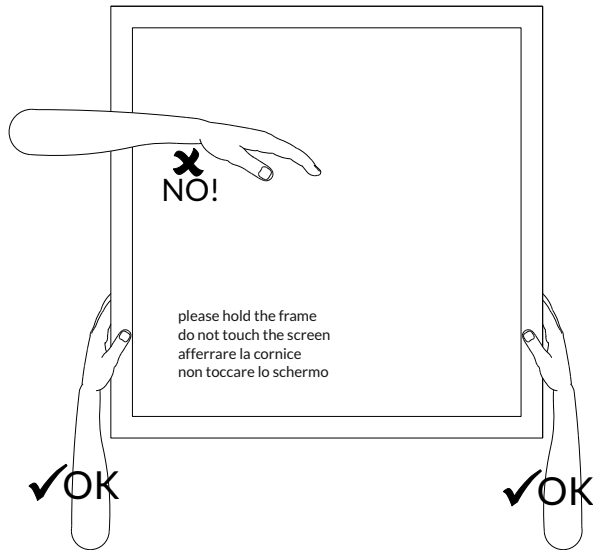

// **Avvertenze.** La sicurezza dell'apparecchio è garantita solamente con l'uso appropriato delle presenti istruzioni che devono essere lette e conservate. • Togliere tensione di rete prima della sostituzione delle lampade e comunque prima di ogni operazione di manutenzione. • Non coprire l'apparecchio con panni o con quant'altro possa causare un eccessivo surriscaldamento. • La nostra azienda declina ogni responsabilità per danni causati da uno scorretto utilizzo o dalla manomissione dell'apparecchio stesso. • Per la sostituzione di componenti usurati rivolgersi a personale qualificato. • L'apparecchio non deve essere smaltito come rifiuto urbano. Deve essere soggetto a raccolta separata per evitare danni all'ambiente nel rispetto della direttiva 2002/96 e delle leggi nazionali per lo smaltimento del prodotto a fine vita. Il mancato rispetto di quanto sopra è sanzionato dalla Legge. • Si prega di informarsi in merito al sistema locale di raccolta differenziata per i prodotti elettrici ed elettronici.

// **Warning.** The safety of the fixture is guaranteed only under the correct use of the present instructions, which have to be read and kept. • Turn off the net voltage before the replacement of the lamp and however before any maintenance action. • Do not cover the fixture with clothes or something else which could cause an excessive overheating. • Our company declines all responsibility for damages caused by an incorrect use or by the tampering of fixture itself. • For replacement of worn out components please address to the skilled staff. • The fixture could not be disposed as urban waste. It must be subject to separate waste collection to avoid environmental damage in compliance with directive 2002/96 and national laws for the disposal of product at the end of its working life. The non-compliance of the above mentioned directive will be sanctioned by Law. • We ask you to kindly get information about local separate waste collection system for electric and electronic products.

ISABE_Rev.03

ABSENT ESSENTIAL

// Istruzioni per il montaggio // Assembly instructions



CE

A+



5 years warranty



Direct Emission



UGR <19



IP40



3000K/4000K



>115 lm/W



CRI >90



Eye safety: RG0/RG1



MacAdams 3



L80/B10 >50.000h



Attenzione: prima di procedere con ciascuna delle seguenti operazioni, togliere la tensione di rete ed utilizzare i guanti in dotazione.

Attention: before proceeding with each of the following operations, switch off the power supply at the consumer unit. Use the gloves supplied.

Attention: avant de procéder aux opérations suivantes, éteignez la tension de ligne et utilisez les équipements de protection individuelle (gants, lunettes, chaussures).

esse-ci
LIVING LIGHT

Esse-Ci Srl
Viale del Lavoro 25, 35010 Vigonza (PD) Italy
Tel. +39 049 8959511
info@esse-ci.it
www.esse-ci.it

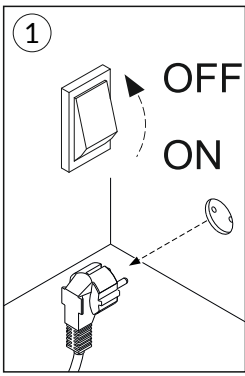

COD		AxB (mm)	R1xR2 (mm)	Y (mm)
41DPL18L_90E	18W	295X295	275X275	200
41DPL36L_90E	36W	595X595	575X575	500
41DPL22L_90EM3	22W	595X295	575X275	500
41DPL36L_90EM3	36W	1195X295	1170X270	915
41DPL60L_90EM6	60W	1195X595	1170X570	900

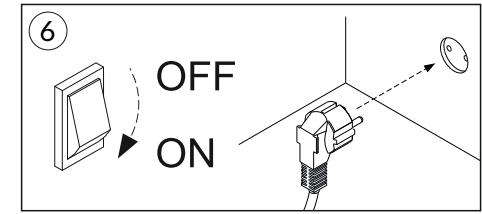
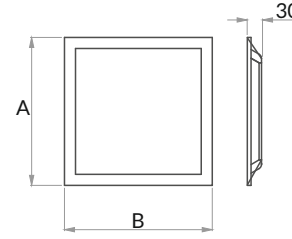

 Non guardare la fonte di luce
Do not stare at the operating light source

Recessed on false ceiling - Incassato su struttura a vista

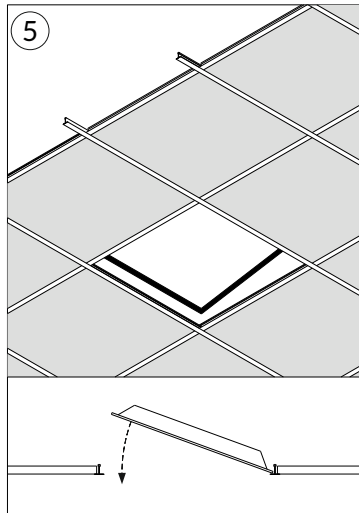
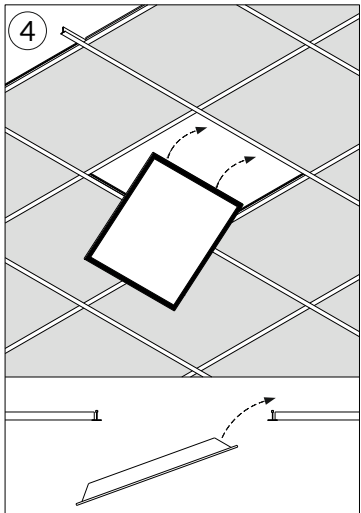
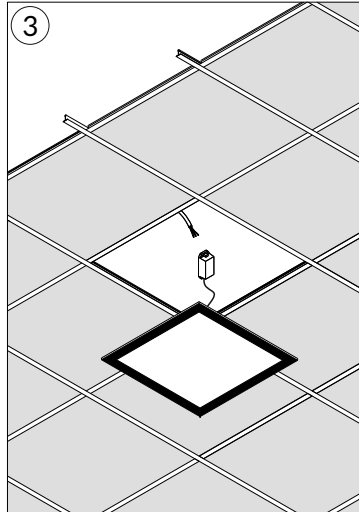
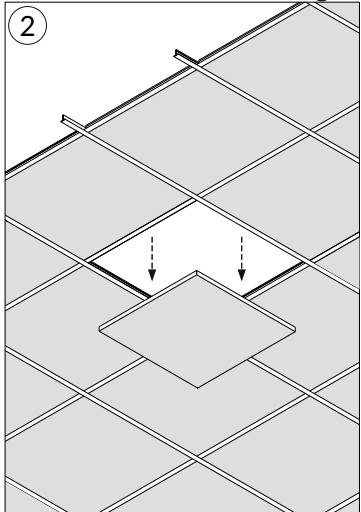

41AA1330E - Suspension kit / kit di sospensione

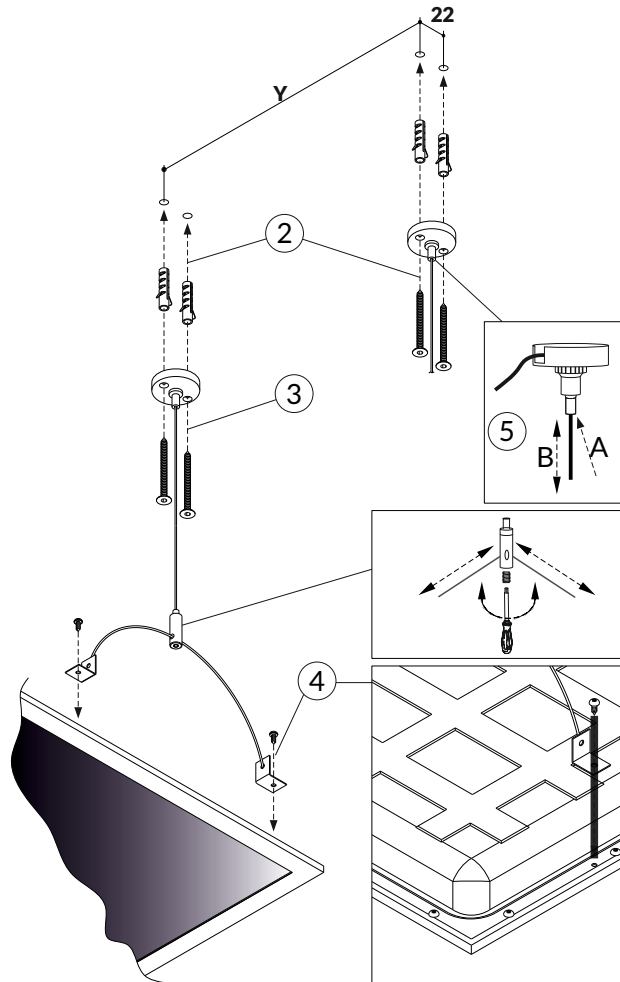

41AA17 - Kit for plasterboard / Kit per cartongesso

41AA17ESN - Kit for hide false ceiling
Kit per controsoffitto a struttura nascosta

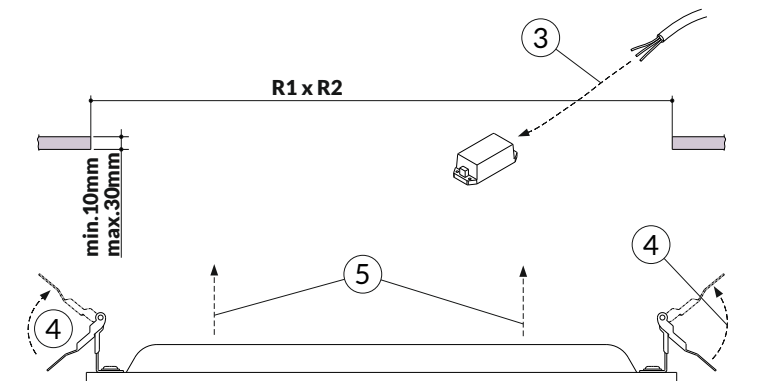
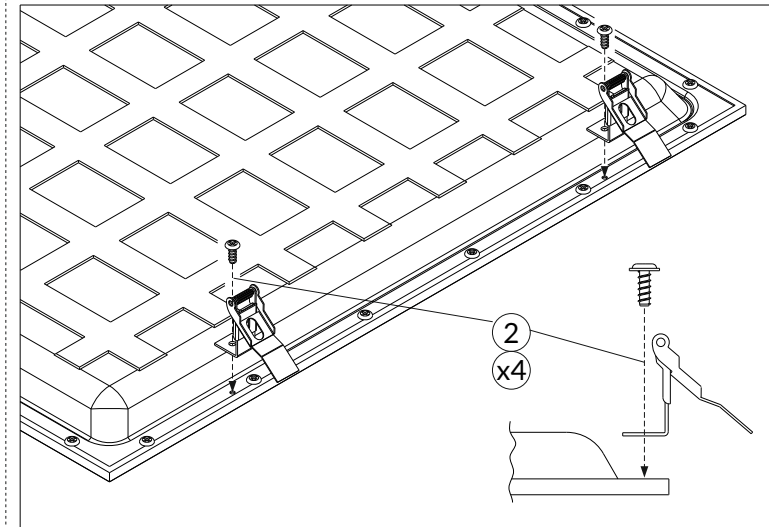

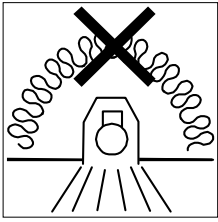

Luminaires not suitable for covering
with thermally insulating material
Gli apparecchi non sono idonei ad essere coperti
con materiale termoisolante

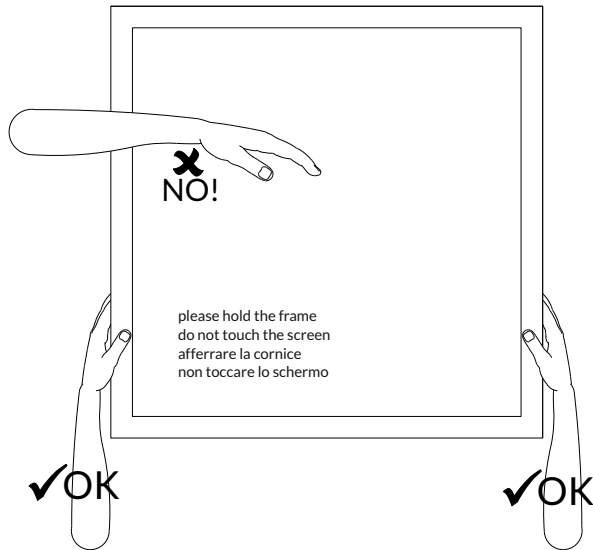

// **Avvertenze.** La sicurezza dell'apparecchio è garantita solamente con l'uso appropriato delle presenti istruzioni che devono essere lette e conservate. • Togliere tensione di rete prima della sostituzione delle lampade e comunque prima di ogni operazione di manutenzione. • Non coprire l'apparecchio con panni o con quant'altro possa causare un eccessivo surriscaldamento. • La nostra azienda declina ogni responsabilità per danni causati da uno scorretto utilizzo o dalla manomissione dell'apparecchio stesso. • Per la sostituzione di componenti usurati rivolgersi a personale qualificato. • L'apparecchio non deve essere smaltito come rifiuto urbano. Deve essere soggetto a raccolta separata per evitare danni all'ambiente nel rispetto della direttiva 2002/96 e delle leggi nazionali per lo smaltimento del prodotto a fine vita. Il mancato rispetto di quanto sopra è sanzionato dalla Legge. • Si prega di informarsi in merito al sistema locale di raccolta differenziata per i prodotti elettrici ed elettronici.

// **Warning.** The safety of the fixture is guaranteed only under the correct use of the present instructions, which have to be read and kept. • Turn off the net voltage before the replacement of the lamp and however before any maintenance action. • Do not cover the fixture with clothes or something else which could cause an excessive overheating. • Our company declines all responsibility for damages caused by an incorrect use or by the tampering of fixture itself. • For replacement of worn out components please address to the skilled staff. • The fixture could not be disposed as urban waste. It must be subject to separate waste collection to avoid environmental damage in compliance with directive 2002/96 and national laws for the disposal of product at the end of its working life. The non-compliance of the above mentioned directive will be sanctioned by Law. • We ask you to kindly get information about local separate waste collection system for electric and electronic products.









ISABEC

ABSENT ESSENTIAL

CE

41AAE_ // Kit for ceiling installation // Kit per installazione a plafone
// Istruzioni per il montaggio // Assembly instructions

A+

-  5 years warranty
-  Direct Emission
-  UGR <19
-  IP40
-  3000K/4000K
-  >115 lm/W
-  CRI >90
-  Eye safety: RG0/RG1
-  Mac Adams 3
-  L80/B10 >50.000h



Attenzione: prima di procedere con ciascuna delle seguenti operazioni, togliere la tensione di rete ed utilizzare i guanti in dotazione.

Attention: before proceeding with each of the following operations, switch off the power supply at the consumer unit. Use the gloves supplied.

Attention: avant de procéder aux opérations suivantes, éteignez la tension de ligne et utilisez les équipements de protection individuelle (gants, lunettes, chaussures).

esse-ci
LIVING LIGHT

Esse-Ci Srl
Viale del Lavoro 25, 35010 Vigonza (PD) Italy
Tel. +39 049 8959511
info@esse-ci.it
www.esse-ci.it

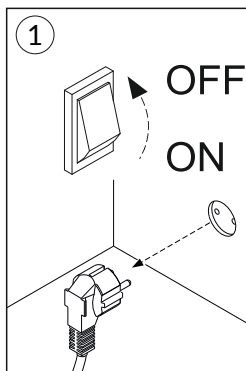

COD		AxB (mm)	41AA_	CxD (mm)
41DPL18L_90E	18W	295X295	/	/
41DPL36L_90E	36W	595X595	41AA600600	340X558
41DPL22L_90M3	22W	595X295	41AA600300	340X258
41DPL36L_90M3	36W	1195X295	41AA1200300	700X258
41DPL60L_90M6	60W	1195X595	41AA1200600	700X558

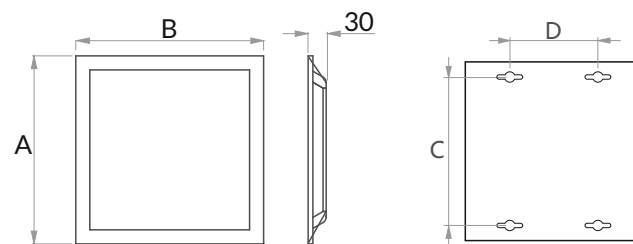

Non guardare la fonte di luce
Do not stare at the operating light source

