

# GROOVE IP54



ID CODE: 43

GROOVE IP54 is a product created specifically for applications that demand high ingress protection against dust and moisture. Perfectly complimenting the interior GROOVE collection, the product has been designed to be installed either as a single luminaire, or with accessories in **continuous rows**, making this a unique product that allows designers freedom to create stunning installations. The **aluminum body and the flexible diffuser** with co-extruded gaskets, guarantee maximum performance, achieving a protection rating of IP54, making the collection ideal for industrial / commercial applications, or even for **protected outdoor use**.







See also:

<b>GROOVE</b>	p. 58
<b>GROOVE HCL</b>	p. 480
<b>GROOVE DISPLAY</b>	p. 122
<b>GROOVE DISPLAY IP54</b>	p. 438
<b>GROOVE DISPLAY HCL</b>	p. 481

## FEATURES

-  Direct Emission
-  UGR < 22
-  IP 54



## LED

-  3000K/4000K
-  >90 lm/W; >102 lm/W
-  CRI > 90
-  Eye safety: RG0/RG1
-  Mac Adams 3
-  L80/B10 >50.000h

## CERTIFICATIONS

-  CE
-  A++
-  5 years warranty

## ON REQUEST

-  DALI - RDD code (verify the version)
-  Emergency kit 1/3 hour EM/EM 3h code
-  5000K

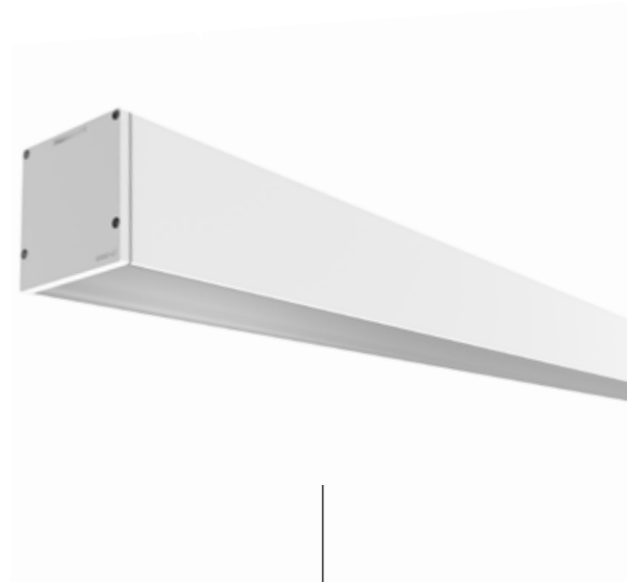

Design  
esse-ci

**Specifications** Built-in driver.

**Optic** Methacrylate satin antistatic diffuser screen, UGR<22.

**Body** Aluminum extruded body with epoxy powder coating.

**Colour** ○ White matt RAL 9003 - Code: B  
● Black matt RAL 9005 - Code: C8



## GROOVE IP54 LOW POWER

### OPTIC

Methacrylate satin antistatic diffuser screen, UGR<22 to be ordered separately.

End caps not included. See accessories on p. 436.

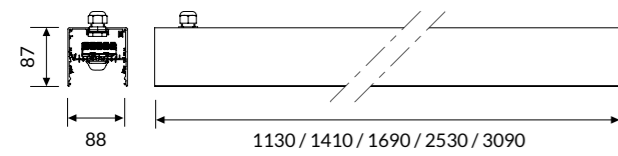

For single installation, add 15mm at the profile length for the end cap kit.  
For continuous rows, add to the sum of the profile lengths 1,5mm\*(n° fixture-1) for the gasket and 15mm for the end cap kit.

IP 54 A\*\*

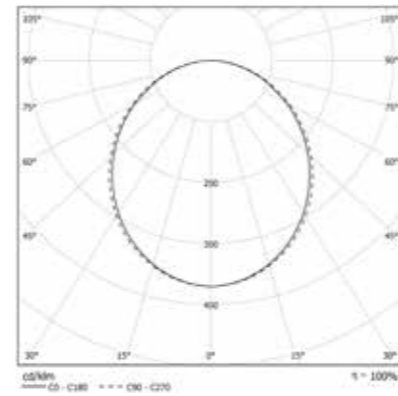

## GROOVE IP54 HIGH POWER

### OPTIC

Methacrylate satin antistatic diffuser screen, UGR<22 to be ordered separately.

End caps not included. See accessories on p. 436.

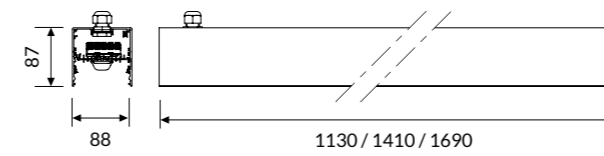

For single installation, add 15mm at the profile length for the end cap kit.  
For continuous rows, add to the sum of the profile lengths 1,5mm\*(n° fixture-1) for the gasket and 15mm for the end cap kit.

IP 54 A\*\*

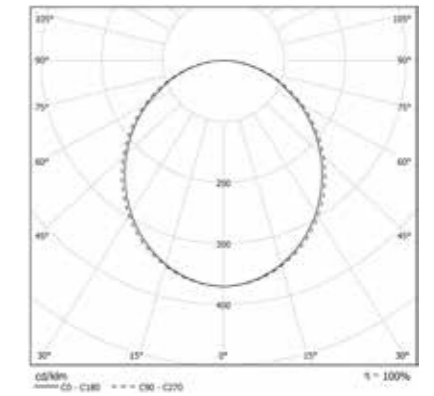

### COLOUR TEMPERATURE

4000K

COD	💡	lm	mm
43AA24L49054	24W	2436	1130
43AA30L49054	30W	3045	1410
43AA36L49054	36W	3654	1690
43AA54L49054	54W	5481	2530
43AA66L49054	66W	6699	3090

3000K

COD	💡	lm	mm
43AA24L39054	24W	2268	1130
43AA30L39054	30W	2835	1410
43AA36L39054	36W	3402	1690
43AA54L39054	54W	5103	2530
43AA66L39054	66W	6237	3090

### COLOUR TEMPERATURE

4000K

COD	💡	lm	mm
43AA45L490HP54	45W	4482	1130
43AA57L490HP54	57W	5677	1410
43AA68L490HP54	68W	6773	1690

3000K

COD	💡	lm	mm
43AA45L390HP54	45W	4172	1130
43AA57L390HP54	57W	5284	1410
43AA68L390HP54	68W	6304	1690

Accessories



**43AA1354**  
Single wire 1500mm long adjustable suspension kit.



**43AA133054**  
Single wire 3000mm long adjustable suspension kit.



**43AA1454**  
Kit for ceiling mounting.



**43AA1654**  
3 poles-ceiling rose power cable. Cable length 2000mm.



**43AA165P54**  
5 poles-ceiling rose power cable. Cable length 2000mm.



**43AA0954**  
End caps kit for suspended and ceiling version.



**43AA1154**  
Linear joint for suspended and ceiling version.



**43PG1133**  
**43PG1413**  
**43PG1693**  
**43PG2533**  
**43PG3093**  
PG diffuser from 1133/1413/1693/2533/3093mm.



**43PG10000**  
Methacrylate satin diffuser UGR<22, 10m coil to be measured and cut on site to provide continuous gap-free light diffusion.

Technical Note

CONTINUOUS ROW INSTALLATION

