

BEN**ID CODE: 1.0**

Universal fixture produced with **spun aluminium**, for wall, ceiling, suspended or recessed applications. For applications where low glare is desirable, DPL optics are offered which have a glare rating of UGR <19. A satin opal diffuser is also offered for soft broad-beam distribution UGR <22.

The **LED boards are mounted on circular aluminium frames** for optimum thermal management and quick fit connectors facilitate rapid installation. Dimming and emergency versions complete the range.





See also:

BEN recessed	p. 212
BEN wall	p. 384
BEN IP54	p. 520
BEN HCL	p. 478









Design
Serge & Robert Cornelissen

FEATURES

-  Direct Emission
-  Direct/Indirect Emission
-  UGR <19; <22
-  IP 40





LED

-  3000K/4000K
-  >124 lm/W
-  CRI >90
-  Eye safety: RG0/RG1
-  Mac Adams 3
-  L80/B10 >50.000h

CERTIFICATIONS

-  CE
-  A+
-  5 years warranty
- 

ON REQUEST

-  DALI - RDD code (verify the version)
-  BT Easy connect - BEM/BES code
-  Emergency kit 1/3 hour EM/EM 3h code
-  2700K

Specifications · Built-in driver

Optic · PG with frosted Acryl-Satiné and impact resistant diffuser UGR<22
· DPL impact resistant with homogeneous and controlled emission UGR<19 (accessory)

Body Spun aluminum with epoxy powder coating.

Colour ○ Matt white RAL 9003 - Code: B



BEN SMALL IP40 PG

OPTIC

PG diffuser with frosted Acryl-Satiné and impact resistant diffuser UGR<22.

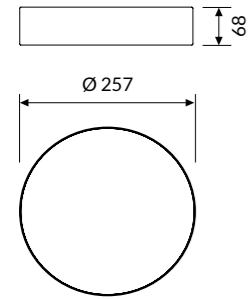

IP 40 A'

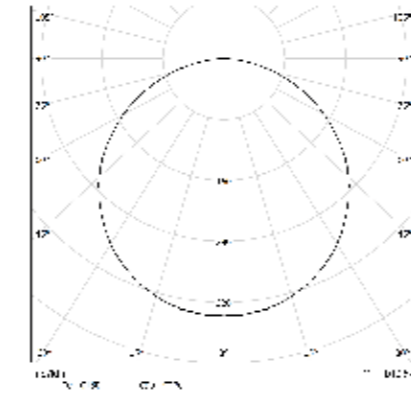

COLOUR TEMPERATURE

4000K

3000K

COD	💡	lm	Ø (mm)
10PG6L490	6W	749	257
10PG12L490	12W	1497	257
10PG18L490	18W	2246	257

COD	💡	lm	Ø (mm)
10PG6L390	6W	712	257
10PG12L390	12W	1422	257
10PG18L390	18W	2138	257

BEN SMALL IP40 PG DOUBLE EMISSION

OPTIC

PG diffuser with frosted Acryl-Satiné and impact resistant diffuser UGR<22.

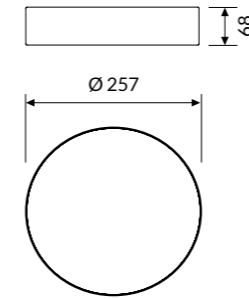

IP 40 A'

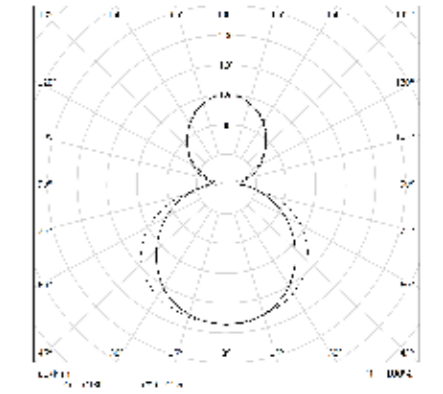

DIRECT // INDIRECT EMISSION

Ø (mm)	Power Direct Mod.	Power Indirect Mod.
257	6W	9W
257	12W	9W
257	18W	9W

COLOUR TEMPERATURE

4000K

3000K

COD	💡	lm	Ø (mm)
10DI15PGL490	15W	1965	257
10DI21PGL490	21W	2713	257
10DI27PGL490	27W	3462	257

COD	💡	lm	Ø (mm)
10DI15PGL390	15W	1859	257
10DI21PGL390	21W	2569	257
10DI27PGL390	27W	3285	257

BEN MEDIUM IP40 PG

OPTIC

PG diffuser with frosted Acryl-Satiné and impact resistant diffuser UGR<22.

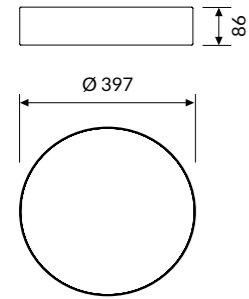

IP 40 A'

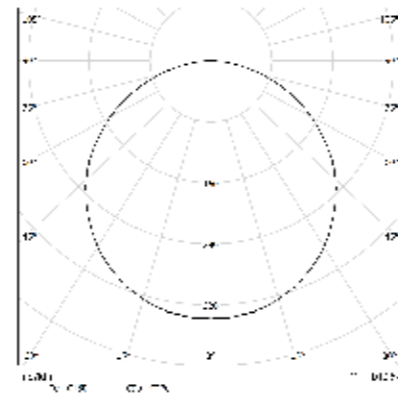

COLOUR TEMPERATURE 4000K

COD	💡	lm	Ø (mm)
10PG16L490	16W	1994	397
10PG25L490	25W	3113	397

COLOUR TEMPERATURE 3000K

COD	💡	lm	Ø (mm)
10PG16L390	16W	1894	397
10PG25L390	25W	2957	397

BEN MEDIUM IP40 PG DOUBLE EMISSION

OPTIC

PG diffuser with frosted Acryl-Satiné and impact resistant diffuser UGR<22.

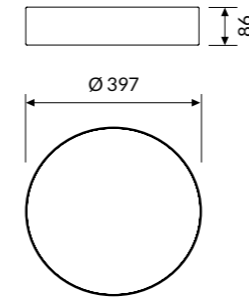

IP 40 A'

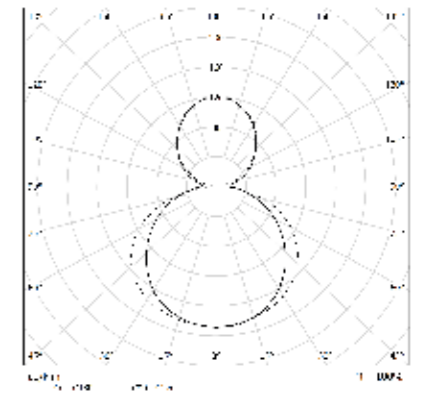

DIRECT // INDIRECT EMISSION

Ø (mm)	Power Direct Mod.	Power Indirect Mod.
397	16W	12W
397	25W	12W

COLOUR TEMPERATURE 4000K

COD	💡	lm	Ø (mm)
10DI28PGL490	28W	3616	397
10DI37PGL490	37W	4735	397

COLOUR TEMPERATURE 3000K

COD	💡	lm	Ø (mm)
10DI28PGL390	28W	3424	397
10DI37PGL390	37W	4487	397

BEN LARGE IP40 PG

OPTIC

PG diffuser with frosted Acryl-Satiné and impact resistant diffuser UGR<22.

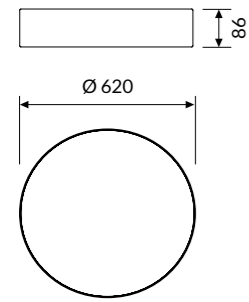

IP 40 A'

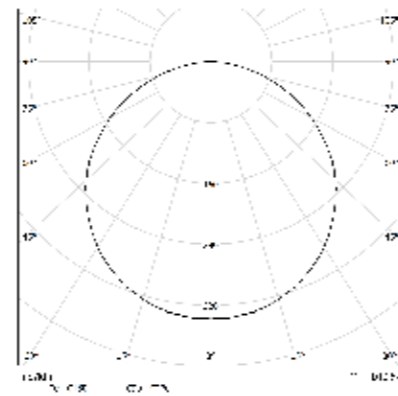

BEN LARGE IP40 PG DOUBLE EMISSION

OPTIC

PG diffuser with frosted Acryl-Satiné and impact resistant diffuser UGR<22.

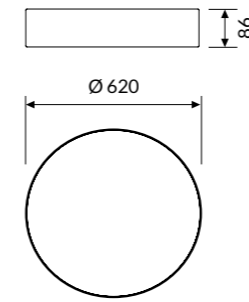

IP 40 A'

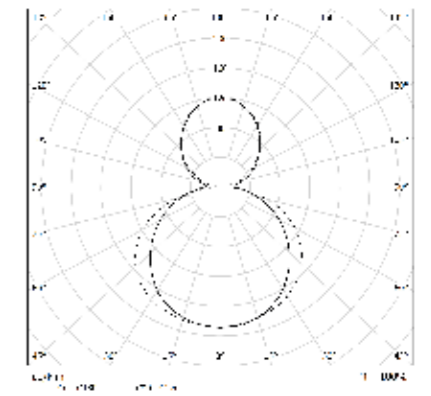

SUSPENDED / CEILING

DIRECT // INDIRECT EMISSION

Ø (mm)	Power Direct Mod.	Power Indirect Mod.
620	60W	24W
620	112W	24W

COLOUR TEMPERATURE 4000K

COD	💡	lm	Ø (mm)
10PG60L490	60W	7476	620
10PG112L490	112W	13955	620

COLOUR TEMPERATURE 3000K

COD	💡	lm	Ø (mm)
10PG60L390	60W	7102	620
10PG112L390	112W	13257	620

COLOUR TEMPERATURE 4000K

COD	💡	lm	Ø (mm)
10DI84PGL490	84W	10689	620
10DI136PGL490	136W	17168	620

COLOUR TEMPERATURE 3000K

COD	💡	lm	Ø (mm)
10DI84PGL390	84W	10131	620
10DI136PGL390	136W	16286	620

BEN XL IP40 PG

OPTIC

PG diffuser with frosted Acryl-Satiné and impact resistant diffuser UGR<22.

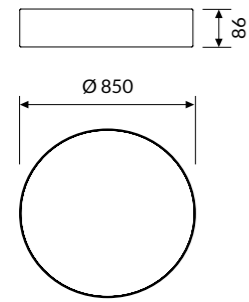

IP 40 A+

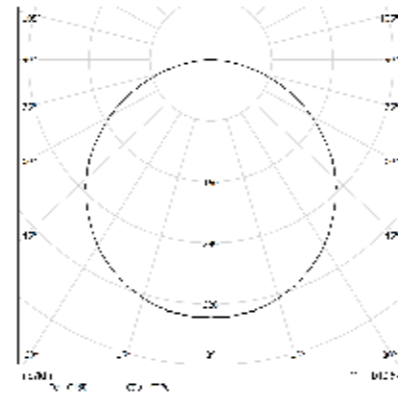

BEN XL IP40 PG DOUBLE EMISSION

OPTIC

PG diffuser with frosted Acryl-Satiné and impact resistant diffuser UGR<22.

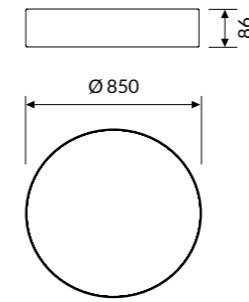

IP 40 A+

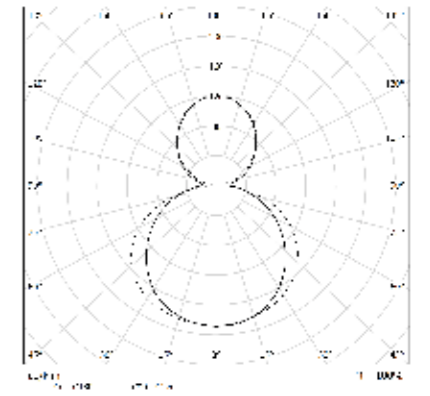

SUSPENDED / CEILING

DIRECT // INDIRECT EMISSION

Ø (mm)	Power Direct Mod.	Power Indirect Mod.
850	70W	30W
850	150W	30W

COLOUR TEMPERATURE 4000K

COD	💡	lm	Ø (mm)
10PG70L490	70W	8722	850
10PG150L490	150W	18690	850

COLOUR TEMPERATURE 3000K

COD	💡	lm	Ø (mm)
10PG70L390	70W	8286	850
10PG150L390	150W	17756	850

COLOUR TEMPERATURE 4000K

COD	💡	lm	Ø (mm)
10DI100PGL490	100W	12738	850
10DI180PGL490	180W	22706	850

COLOUR TEMPERATURE 3000K

COD	💡	lm	Ø (mm)
10DI100PGL390	100W	12072	850
10DI180PGL390	180W	21542	850

BEN MAXI IP40 PG

OPTIC

PG diffuser with frosted Acryl-Satiné and impact resistant diffuser UGR<22.

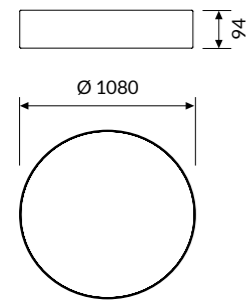

IP 40 A+

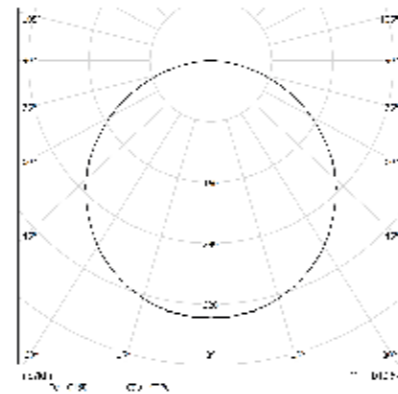

BEN MAXI IP40 PG DOUBLE EMISSION

OPTIC

PG diffuser with frosted Acryl-Satiné and impact resistant diffuser UGR<22.

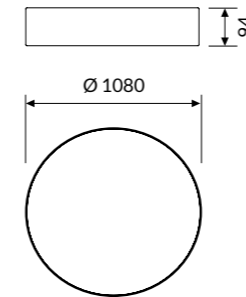

IP 40 A+

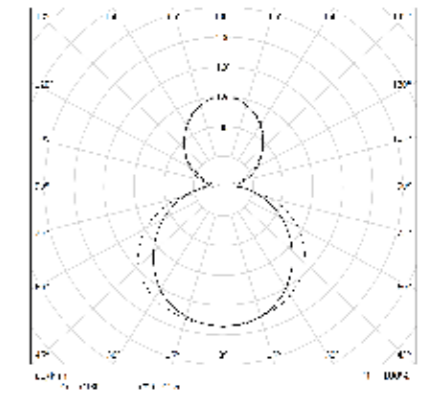

DIRECT // INDIRECT EMISSION

Ø (mm)	Power Direct Mod.	Power Indirect Mod.
1080	180W	36W
1080	240W	36W

COLOUR TEMPERATURE

4000K

3000K

COD	💡	lm	Ø (mm)
10DI216PGL490	216W	27248	1080
10DI276PGL490	276W	34724	1080

COD	💡	lm	Ø (mm)
10DI216PGL390	216W	25851	1080
10DI276PGL390	276W	32953	1080

Accessories



10AADPLS: for BEN SMALL
10AADPLM: for BEN MEDIUM
10AADPLL: for BEN LARGE
10AADPLXL: for BEN XL
10AADPLMX: for BEN MAXI

DPL diffuser for IP40 versions.



10AA13

Single wire 1500mm long adjustable suspension kit.



10AA1330

Single wire 3000mm long adjustable suspension kit.

COLOUR TEMPERATURE

4000K

3000K

COD	💡	lm	Ø (mm)
10PG180L490	180W	22428	1080
10PG240L490	240W	29904	1080

COD	💡	lm	Ø (mm)
10PG180L390	180W	21307	1080
10PG240L390	240W	28409	1080



10AA16

3-poles powered supply box cable length 2000mm.



10AA165P

5-poles powered supply box cable length 2000mm.



10AA14LI

Kit for ceiling mounting.

BEN

ID CODE: 1.0



Universal fixture produced from **spun aluminium**, for wall, ceiling, suspended or recessed applications. For applications where low glare is desirable, DPL optics are offered which have a glare rating of UGR <19. A satin opal diffuser is also offered for soft broad-beam distribution UGR <22.

The **LED boards are mounted on circular aluminium frames** for optimum thermal management and quick fit connectors facilitate rapid installation. Dimming and emergency versions complete the range.







See also:

BEN suspended/ceiling	p. 128
BEN wall	p. 384
BEN IP54	p. 520
BEN HCL	p. 478

FEATURES

-  Direct Emission
-  UGR <19; <22
-  IP 40





LED

-  3000K/4000K
-  >124 lm/W
-  CRI >90
-  Eye safety: RG 0/1
-  Mac Adams 3
-  L80/B10 >50.000h

CERTIFICATIONS

-  CE
-  A+
-  5 years warranty
-  ETL

ON REQUEST

-  DALI - RDD code (verify the version)
-  BT Easy connect - BEM/BES code
-  Emergency kit 1/3 hour EM/EM 3h code
-  2700K

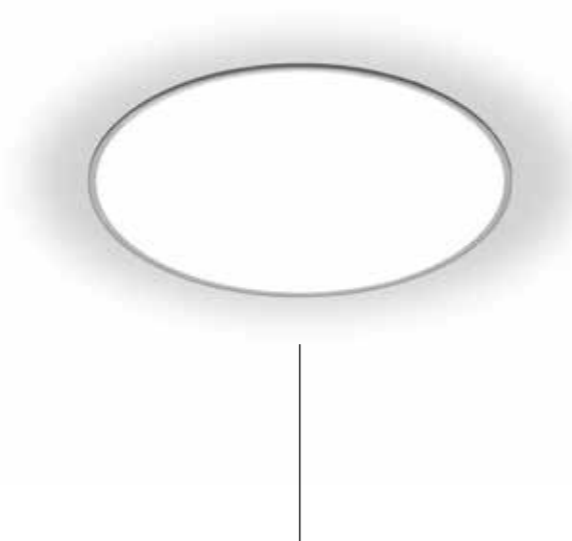

Design
Serge & Robert Cornelissen



Specifications Built-in driver.

Optic

- PG with frosted Acryl-Satiné and impact resistant diffuser UGR<22
- DPL impact resistant with homogeneous and controlled emission UGR<19 (accessory)

Body Spun aluminum with epoxy powder coating.

Colour ○ Matt white RAL 9003 - Code: B

BEN SMALL IP40 PG

OPTIC

PG diffuser with frosted Acryl-Satiné and impact resistant diffuser UGR<22.

Recessed accessory not included.

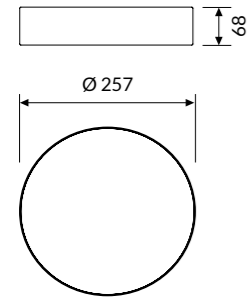

IP 40 A'

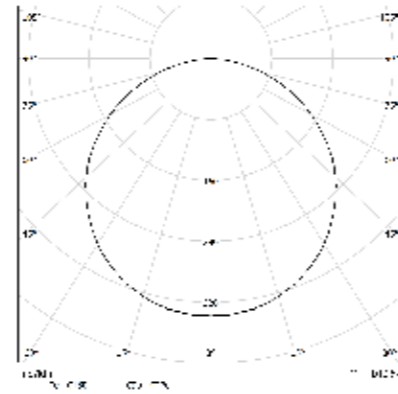

BEN MEDIUM IP40 PG

OPTIC

PG diffuser with frosted Acryl-Satiné and impact resistant diffuser UGR<22.

Recessed accessory not included.

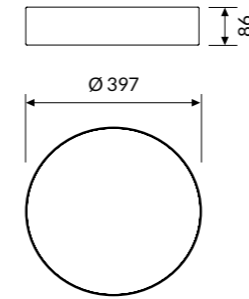

IP 40 A'

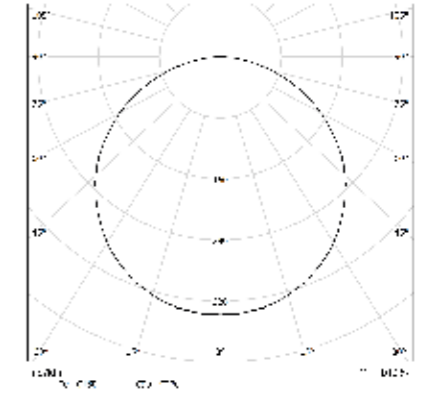

COLOUR TEMPERATURE

4000K

3000K

COD	💡	lm	Ø (mm)
10PG6L490	6W	749	257
10PG12L490	12W	1497	257
10PG18L490	18W	2246	257

COD	💡	lm	Ø (mm)
10PG6L390	6W	712	257
10PG12L390	12W	1422	257
10PG18L390	18W	2138	257

COLOUR TEMPERATURE

4000K

3000K

COD	💡	lm	Ø (mm)
10PG16L490	16W	1994	397
10PG25L490	25W	3113	397

COD	💡	lm	Ø (mm)
10PG16L390	16W	1894	397
10PG25L390	25W	2957	397

BEN LARGE IP40 PG

OPTIC

PG diffuser with frosted Acryl-Satiné and impact resistant diffuser UGR<22.

Recessed accessory not included.

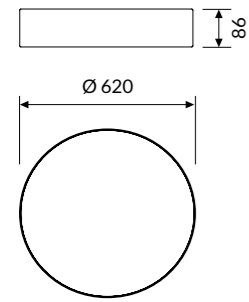

IP 40 A'

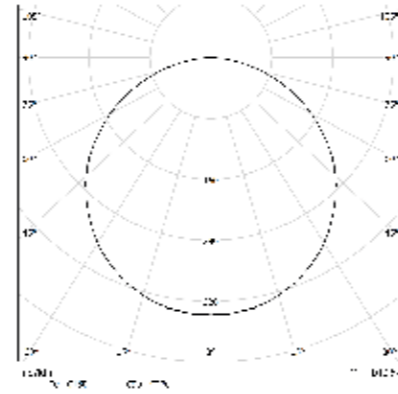

BEN XL IP40 PG

OPTIC

PG diffuser with frosted Acryl-Satiné and impact resistant diffuser UGR<22.

Recessed accessory not included.

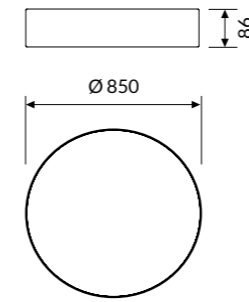

IP 40 A'

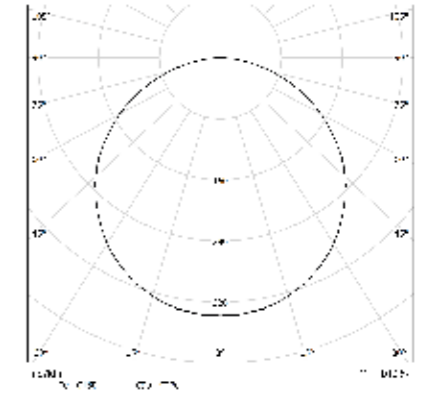

COLOUR TEMPERATURE 4000K

COD	💡	lm	Ø (mm)
10PG60L490	60W	7476	620
10PG112L490	112W	13955	620

COLOUR TEMPERATURE 3000K

COD	💡	lm	Ø (mm)
10PG60L390	60W	7102	620
10PG112L390	112W	13257	620

COLOUR TEMPERATURE 4000K

COD	💡	lm	Ø (mm)
10PG70L490	70W	8722	850
10PG150L490	150W	18690	850

COLOUR TEMPERATURE 3000K

COD	💡	lm	Ø (mm)
10PG70L390	70W	8286	850
10PG150L390	150W	17756	850

BEN MAXI IP40 PG

OPTIC

PG diffuser with frosted Acryl-Satiné and impact resistant diffuser UGR<22.

Recessed accessory not included.

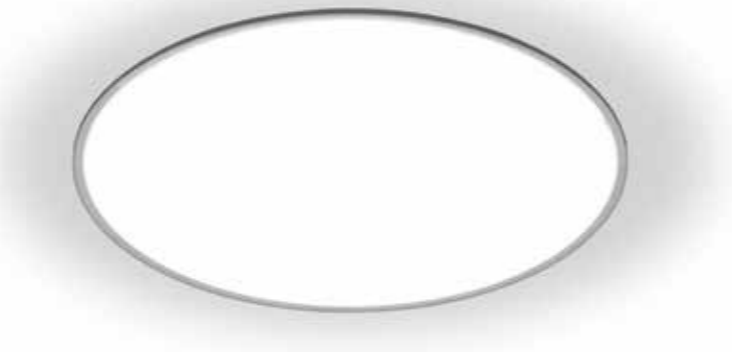
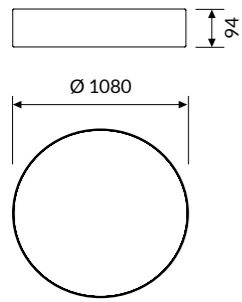

IP 40 A+

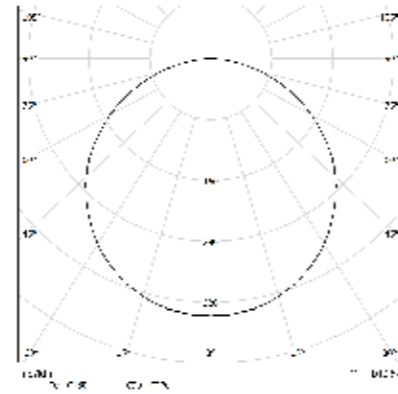

Accessories



10AADPLS: for BEN SMALL
10AADPLM: for BEN MEDIUM
10AADPLL: for BEN LARGE
10AADPLXL: for BEN XL
10AADPLMX: for BEN MAXI

DPL diffuser for IP40 versions.



10AA19SFL: for BEN SMALL
10AA19MFL: for BEN MEDIUM
10AA19LFL: for BEN LARGE
10AA19XLFL: for BEN XL
10AA19MXFL: for BEN MAXI

Kit for recessed frameless installation on plasterboard and concrete.



10AA19S: for BEN SMALL
10AA19M: for BEN MEDIUM
10AA19L: for BEN LARGE
10AA19XL: for BEN XL
10AA19MX: for BEN MAXI

Kit for recessed installation.

COLOUR TEMPERATURE

4000K

3000K

COD	💡	lm	Ø (mm)
10PG180L490	180W	22428	1080
10PG240L490	240W	29904	1080

COD	💡	lm	Ø (mm)
10PG180L390	180W	21307	1080
10PG240L390	240W	28409	1080

BEN

ID CODE: 10

Universal fixture produced with spun aluminium, for wall, ceiling, suspended or recessed applications. For applications where low glare is desirable, DPL optics are offered which have a glare rating of UGR <19. A satin opal diffuser is also offered for soft broad-beam distribution UGR <22.

The LED boards are mounted on circular aluminium frames for optimum thermal management and quick fit connectors facilitate rapid installation. Dimming and emergency versions complete the range.

See also:

BEN suspended/ceiling	p. 128
BEN recessed	p. 212
BEN IP54	p. 520
BEN HCL	p. 478



Design
Serge & Robert Cornelissen

FEATURES

- Direct Emission
- UGR <22
- IP 40

LED

- 3000K/4000K
- >124 lm/W icon"/> >124 lm/W
- CRI >90
- Eye safety: RG0/RG1
- Mac Adams 3
- L80/B10 >50.000h

CERTIFICATIONS

- CE
- A+
- 5 years warranty
- ETL

ON REQUEST

- DALI - RDD code (verify the version)
- BT Easy connect - BEM/BES code
- Emergency kit 1/3 hour EM/EM 3h code
- 2700K

Specifications Built-in driver.

Optic PG with frosted Acryl-Satiné and impact resistant diffuser UGR<22.

Body Spun aluminum with epoxy powder coating.

Colour ○ Matt white RAL 9003 - Code: B

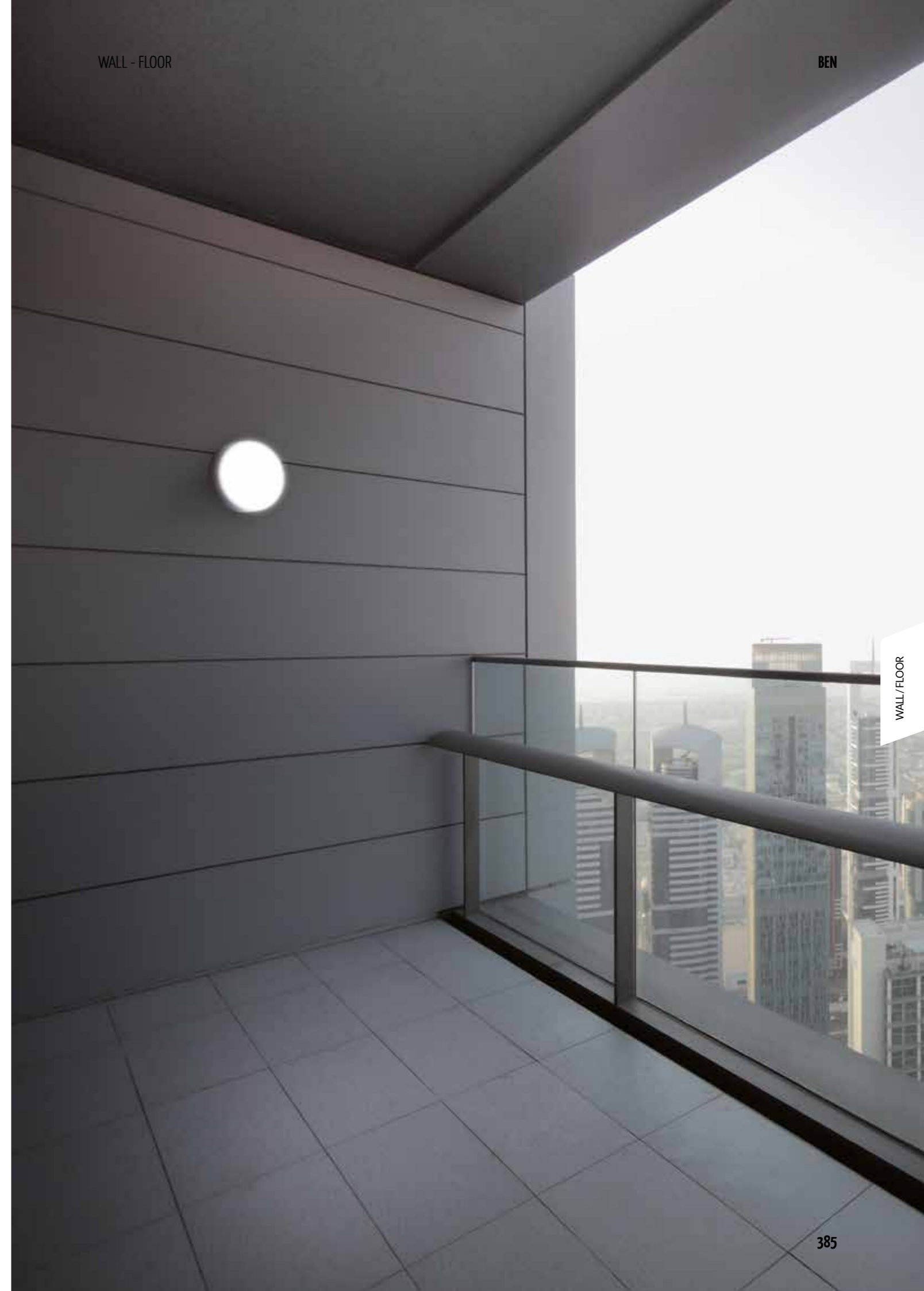

BEN SMALL IP40 PG

OPTIC

PG diffuser with frosted Acryl-Satiné and impact resistant diffuser UGR<22.

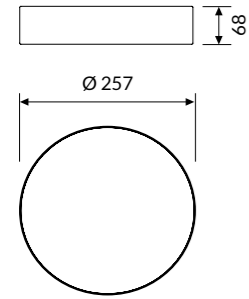

COLOUR TEMPERATURE 4000K

COD	💡	lm	Ø (mm)
10PG6L490	6W	749	257
10PG12L490	12W	1497	257
10PG18L490	18W	2246	257

IP 40 A+

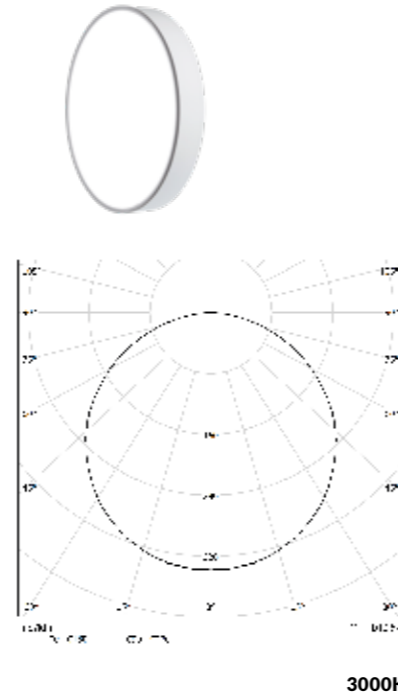

COLOUR TEMPERATURE 3000K

COD	💡	lm	Ø (mm)
10PG6L390	6W	712	257
10PG12L390	12W	1422	257
10PG18L390	18W	2138	257

BEN MEDIUM IP40 PG

OPTIC

PG diffuser with frosted Acryl-Satiné and impact resistant diffuser UGR<22.

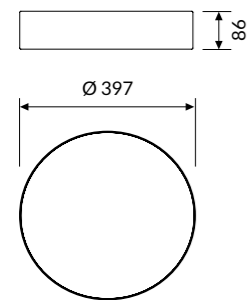

COLOUR TEMPERATURE 4000K

COD	💡	lm	Ø (mm)
10PG16L490	16W	1994	397
10PG25L490	25W	3113	397

IP 40 A+

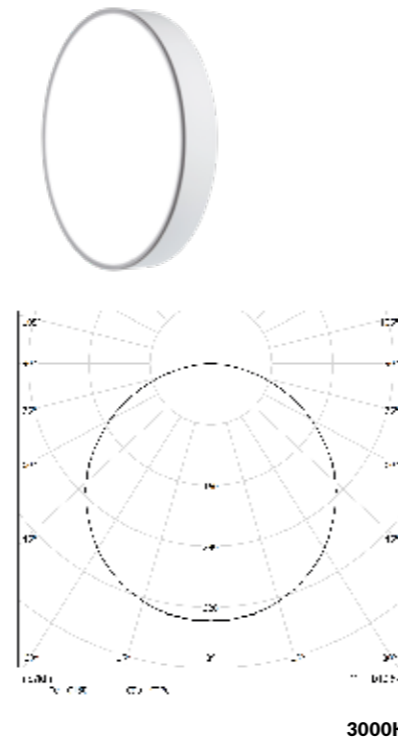

COLOUR TEMPERATURE 3000K

COD	💡	lm	Ø (mm)
10PG16L390	16W	1894	397
10PG25L390	25W	2957	397

BEN LARGE IP40 PG

OPTIC

PG diffuser with frosted Acryl-Satiné and impact resistant diffuser UGR<22.

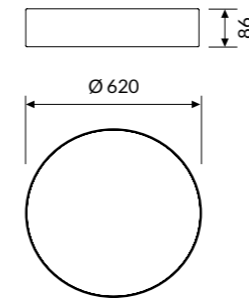

COLOUR TEMPERATURE 4000K

COD	💡	lm	Ø (mm)
10PG60L490	60W	7476	620
10PG112L490	112W	13955	620

IP 40 A+

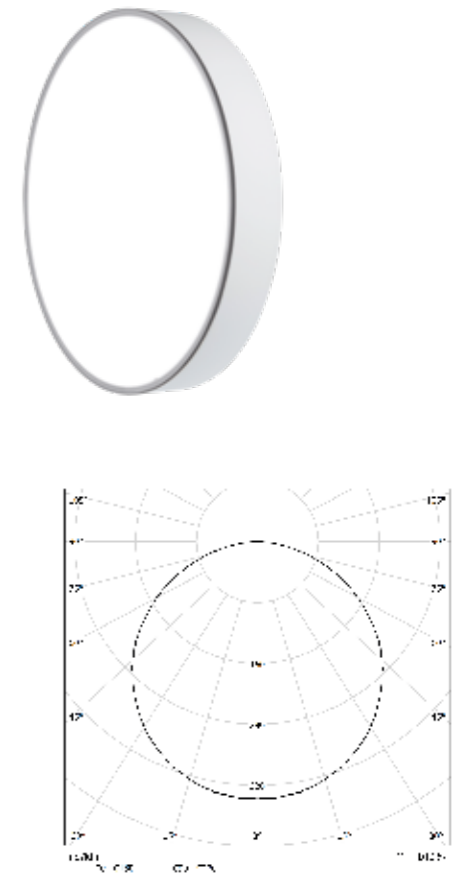

COLOUR TEMPERATURE 3000K

COD	💡	lm	Ø (mm)
10PG60L390	60W	7102	620
10PG112L390	112W	13257	620