

ARKEON MED

ID CODE: 46

ARKEON MED is the new bed-head unit developed by Esse-ci to meet the lighting and functional needs of **hospital or care facilities**. Thanks to the use of latest generation components ARKEON MED guarantees **efficiency and reliability** and integrates perfectly into the spaces with a simple and linear design, ideal for easy cleaning. The control devices are **ergonomic and easily accessible** and the **great versatility** of the product makes ARKEON MED suitable for all **healthcare applications**.





See also:

ARKEON	p. 38
ARKEON WALL	p. 370
ARKEON HCL	p. 477







Design
esse-ci

FEATURES

-  Direct Emission
-  Direct/Indirect Emission
-  Reading emission
-  UGR < 22
-  IP 40





LED

-  3000K/4000K
- >116 lm/W icon" data-bbox="157 558 172 573"/> >116 lm/W
-  CRI > 90
-  Eye safety: RG0/RG1
-  Mac Adams 3
-  L80/B10 > 50.000h

CERTIFICATIONS

-  CE
-  A++
-  5 years warranty

ON REQUEST

-  DALI - RDD code (verify the version)
-  Emergency kit 1/3 hour EM/EM 3h code
-  2700K - 6500K
-  HCL
HUMAN CENTRIC LIGHTING

Specifications

- Built-in driver
- 24V IP67 keyboard with 2 m cable and tear-proof system positioned on the right or left side
- 1 socket 2P+E 10/16A

Optic

- PG frosted diffuser UGR<22 for direct emission
- Polycarbonate asymmetric lens for indirect emission

Body

Aluminum extruded body with epoxy powder coating.

Colour

- Matt white RAL 9003 - Code: B
- Matt black RAL 9005 - Code: C8



ARKEON MED

Device complete with 24V control panel with 2 buttons (reading light, nurse call), 2000mm cable and tear-proof system, 1 socket 2E+ T 10/16A.

Available in right (DX) or left (SX) socket versions.

OPTIC

Direct emission with asymmetric lens.

Indirect emission with frosted diffuser.

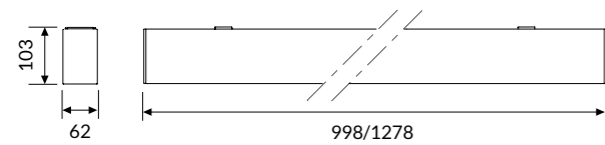

IP 67 A++

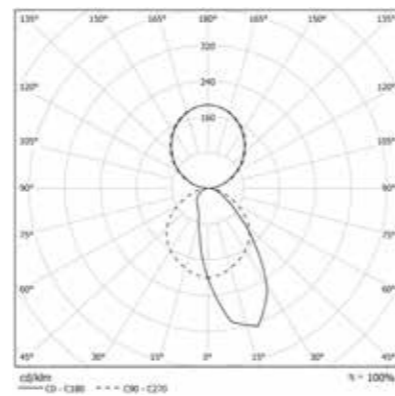

DIRECT // INDIRECT EMISSION

mm	Power Direct Mod.	Power Indirect Mod.
998	14W	30W
1278	19W	40W

COLOUR TEMPERATURE

4000K

COD	Light Bulb Icon	lm	mm
46DI44L42PP1PDX	44W	4620	998
46DI44L42PP1PSX	44W	4620	998
46DI59L42PP1PDX	59W	6195	1278
46DI59L42PP1PSX	59W	6195	1278

3000K

COD	Light Bulb Icon	lm	mm
46DI44L32PP1PDX	44W	4532	998
46DI44L32PP1PSX	44W	4532	998
46DI59L32PP1PDX	59W	6077	1278
46DI59L32PP1PSX	59W	6077	1278

ARKEON MED FREE

In its FREE version, ARKEON MED meets the most varied customization needs, offering countless configuration possibilities, adapting to different design and functional needs.

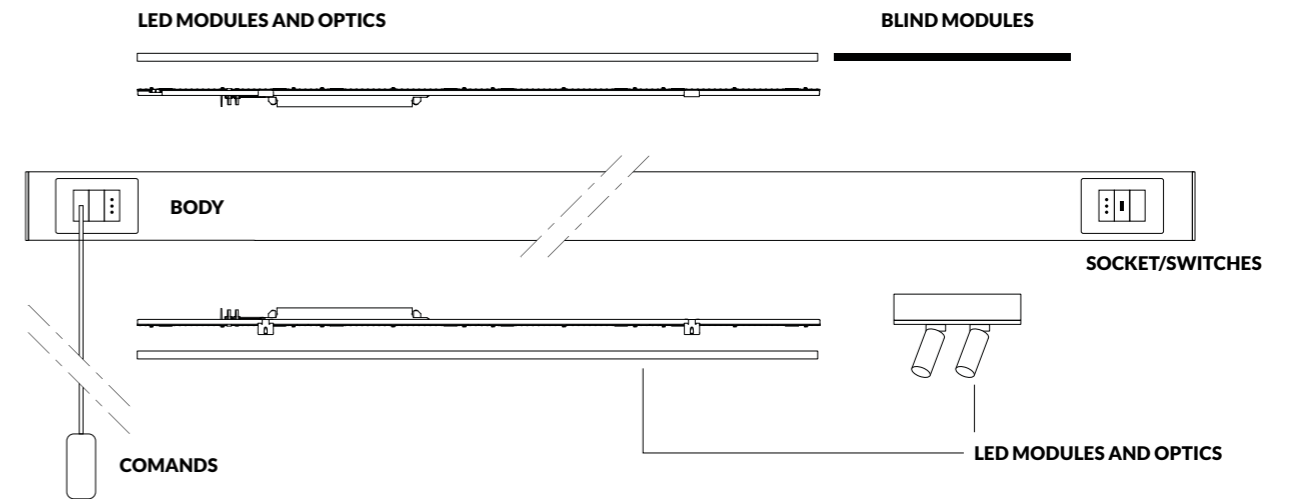

BODY

Pre-wired aluminum body, available lengths from 900mm to 4000mm Colours Stnd black, white, customizable on request.

BLIND MODULES

Blind module in painted roll adaptable to size on site.

LED MODULES AND OPTICS

Direct light led module with asymmetrical 3000K/4000K/HLC optics.

Indirect light led module with 3000K/4000K/HLC soft light diffuser (read/general).

Spot module with adjustable beam lens from 10° to 40°.

SOCKET/SWITCHES

Bypass socket 2P+E 10/16A - Universal socket - USB socket.
Switch - Two-pole switch - Pushbutton.

COMANDS

Tie rod for nurse call.
24V control panel with 2/3 buttons (reading light, direct light, call nurse) with L2000mm cable.
BT system for management with free App.

Technical Note

TYPES OF LIGHTING



All ON mode:
 - indirect environmental emission
 - direct asymmetric emission

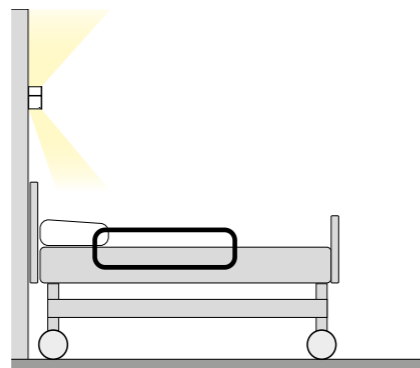

Visit mode:
 - direct asymmetric emission

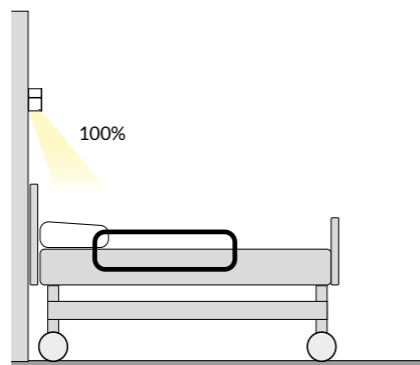

Reading mode:
 - partial direct asymmetric emission

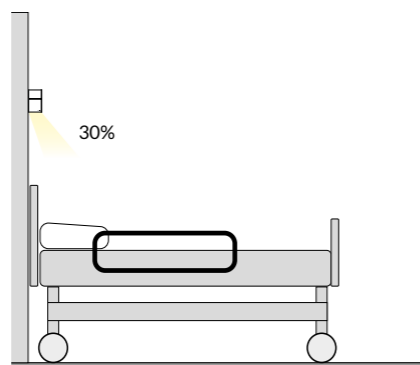

ARKEON MED FREE CONFIGURATION

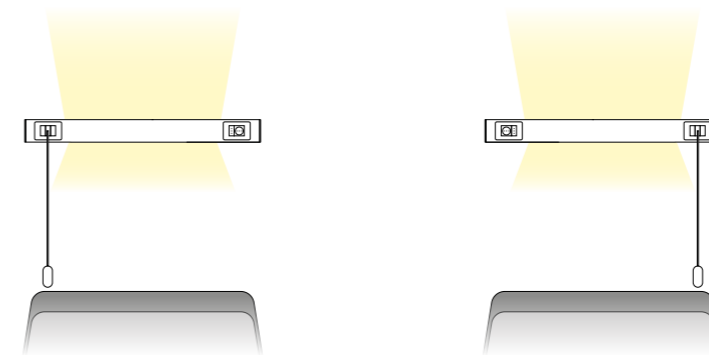

Configuration with distinct elements.

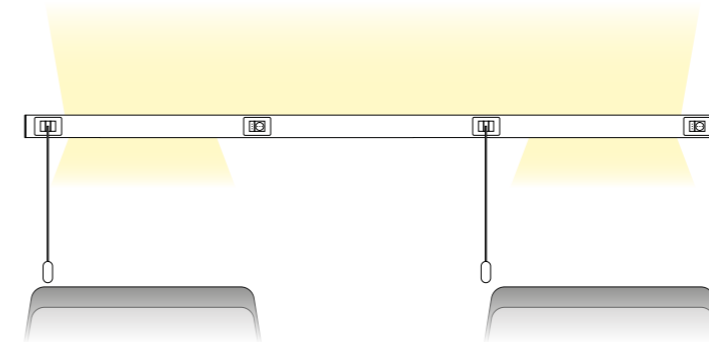

Configuration with single element length 4m, seamless indirect emission.

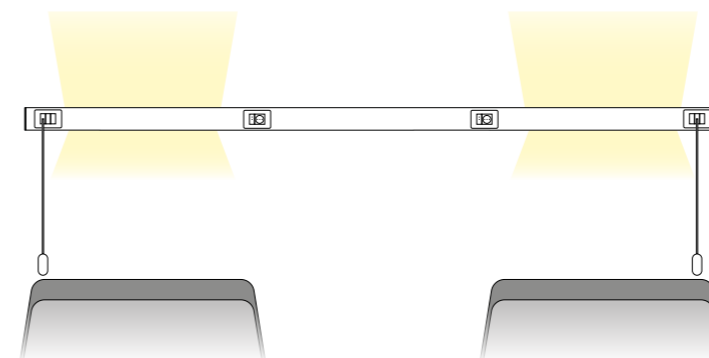

Configuration with single element length 4m, separate indirect emission.



24V control panel.



Universal socket + USB socket.